

# Office and Public Space

**intuit**  
BY SOFTREND

Furniture Collection 2025

## SEATING & WORKSATIONS

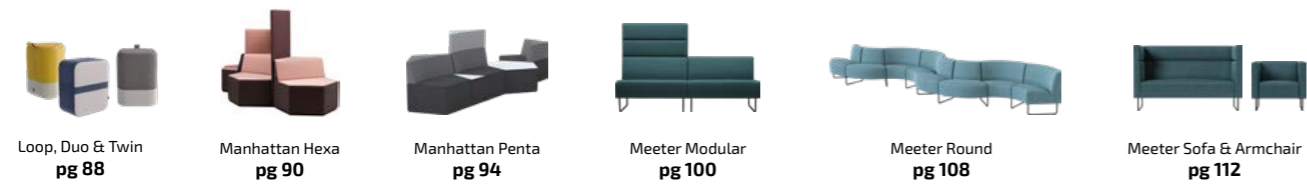

## PHONE POD



Intuit Booth  
pg 150

## TABLES



## SCREENS, SPACE DIVIDERS & WALL PANELS



# CONTENTS

## Intro

Environment matters	4
From Tradition to Innovation: the Intuit story	16
Intuit by Softrend and Sustainability	18
Sound-absorbing furniture	26

## Collection

### Seating & workstations

August	30
August Workbay	38
August Nook	44
August Wall	48
Ben	52
Don	56
Frankie	60
Harles	66
Hide	72
Hubert & Hubert Mini	76
Intro	80
Lilja	82
Loop, Duo & Twin	88
Manhattan Hexa	90
Manhattan Penta	94
Meeter Modular	100
Meeter Round	108
Meeter Sofa & Armchair	112
Meeter Workbay	118
Meeter Chair	124
Sans	126
Sofi	136
Spot	140
Wander	146

### Phone pod

Intuit Booth	150
--------------	-----

### Tables

Aide	154
Alfred	158
Flow	160
Kuubik	164
Kuubik Side Table	168
Rolf	170

### Screens, space dividers & wall panels

Grow	172
Hover	176
Note	180
Silent Note	182
Oaas	184
Sigmund	190

### Fabrics

Standard Fabric Collection	192
----------------------------	-----

# ENVIRONMENT MATTERS

At Intuit by Softrend, we understand that environments matter. Whether it's in the office or public spaces like educational facilities, libraries, cafeterias or public waiting areas, our furniture designs are crafted not only to fill spaces but to transform them. We believe in creating settings that nurture creativity, foster collaboration, and enhance productivity, making every space intuitive and lively. Each of Intuit's furniture pieces is designed with the goal of making spaces more adaptable, functional, and appealing. At Intuit by Softrend, we're committed to redefining how furniture interacts with spaces and its users.



# INTUITIVE FURNISHING FOR GETTING THINGS DONE



Our way of working has changed. It's the creative problem solving, agile collaboration, and the feeling of community we search for in the office. Intuit's designs have evolved to meet this shift.

We've taken the spirit of the breakout space and divided it into 4 distinctive work zones — each designed to meet a particular need to encourage creativity and connection.

Our 4 Zones use modular and multi-functional furniture solutions to make the most of every area of the office. Providing alternate spaces to choose where to work within the office drives a more effective workspace, a better work experience, and better individual performance. A win-win!

The world is moving fast — with Intuit, you make sure office space can keep up.



Welcome Zone



Social Zone



Collaboration Zone



Concentration Zone

INTUITIVE OFFICE



## INSPIRING LEARNING SPACES

At Intuit, we understand that effective learning environments extend beyond the traditional classroom setup of desks and chairs. Our vision is to create versatile spaces that cater to every aspect of the educational journey — from quiet study areas equipped with screens to dynamic group workspaces and comfortable lounges for relaxation and social interaction.

Our range of school furniture is designed to enrich learning experiences across all educational stages, from kindergartens to universities. We prioritize well-being for users of all ages and sizes, ensuring our furniture combines timeless design with functionality. Built to last, our pieces boast durable structures and are easy to maintain, making them a smart investment for long-lasting learning environments.

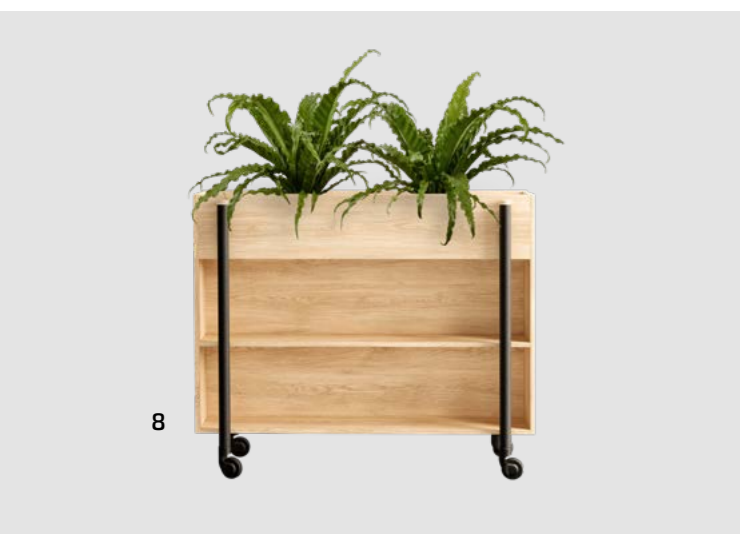

## TRANSFORMING THE WORKPLACE CAFÉ INTO A DYNAMIC HUB

At Intuit, we believe a contemporary workplace café does more than just serve food; it enriches the entire workplace experience. Far from being just a corporate eatery, it's a dynamic, multifunctional hub where employees can dine, meet, work, network, socialize, and reenergize. By activating underutilized spaces throughout the working day, it plays a crucial role in fostering employee productivity and well-being.





## ELEVATING THE LIBRARY SPACE

In the heart of every library, from the quiet corners of reading nooks to the collaborative buzz of communal spaces, the right seating can transform the experience. Intuit's range of library seating furniture is designed to meet every need— whether it's for individual study, group projects, or leisurely reading.

At Intuit, we believe in the power of timeless design, durability, and ease of maintenance to create inviting, long-lasting reading and learning environments. Discover seating solutions that cater to the diverse requirements of modern libraries, ensuring every visitor finds their perfect spot.

## ENHANCING TRANSIT SPACES INTO WELCOMING HUBS

The quality of waiting areas, whether in airports, hospital lobbies, conference centers, or large office buildings, significantly impacts user experience. Our approach to designing for these spaces centers on transforming mere transit areas into inviting hubs that offer comfort and function while waiting.

Inuit's public space collection is crafted to elevate waiting areas into more than just pass-through spaces; they become places where visitors can relax in comfort, catch up on work, or enjoy a peaceful moment away from the hustle and bustle. With Intuit's furniture, waiting becomes an experience in itself, characterized by style, comfort, and utility.





# FROM TRADITION TO INNOVATION: THE INTUIT STORY

## Rooted in Craftsmanship

Intuit by Softrend carries forward a legacy of over 25 years in the furniture industry, grounded in three generations of craftsmanship. Born from the established residential furniture brand Softrend, our journey began in a modest factory in Vääna, Estonia, where every sofa and bed is still handcrafted with precision. By managing every step of the production process, from meticulous quality control to extensive customization options, we uphold the highest standards. Our management system's adherence to ISO 9001:2015 and 14001:2015 reflects our commitment to consistent quality and environmental management.

## Innovating for Tomorrow

With a foundation deeply rooted in Softrend's extensive experience, Intuit by Softrend was launched in 2016 to revolutionize the public space furniture sector. We infuse a spirit of curiosity and innovation into Softrend's traditional expertise, creating functional, sustainable, and stylish furniture.

## Sustainability at the Core

At Intuit, sustainability isn't just a policy; it's a promise to our customers and the planet. We carefully select recyclable materials free from harmful chemicals, focusing on durable design to prolong the life of our products and lessen our environmental impact. Our design philosophy emphasizes product longevity, recyclability, and resource efficiency, ensuring that each piece not only serves its purpose but also contributes positively to the environment.

## Quality and Value

Our mission is to offer high-quality, durable designer furniture at fair prices, ensuring that while our prices are competitive, the quality and craftsmanship remain uncompromised. We believe that a quality product not only lasts longer but also provides greater value over time.

## Vision for the Future

Intuit is driven by a vision to enhance the daily lives of millions by creating the world's most inspiring and comfortable environments. Whether it's transforming offices into collaborative spaces or furnishing public areas like airports and hospitals, our goal is to make every environment a place where it's good to be. Our products are designed to nurture creativity, foster collaboration, and enhance productivity, ensuring that every space we touch is intuitive and vibrant.



THREE GENERATIONS  
OF FURNITURE-  
MAKING TRADITIONS  
SINCE 1997



# INTUIT BY SOFTREND AND SUSTAINABILITY

A growing number of informed consumers seek to make sustainable choices – but they can only do so if manufacturers make them possible. That's why Intuit by Softrend is steadfastly committed to sustainability, believing it's the only way to remain a responsible furniture manufacturer.

We recognize that the furniture industry has a significant environmental footprint. That's why we're taking action to reduce ours across the entire lifecycle of Softrend Group's products.

- 1 Reducing environmental impact by prioritizing chemical-free and recyclable materials.
- 2 Enhancing recyclability by considering the reuse of materials and components from the design phase.
- 3 Extending product lifespans and minimizing the need for replacement by designing durable, repairable products.
- 4 Lowering our ecological footprint through optimized storage, transport, resource efficiency, and weight reduction.

## PRIORITIES OF SOFTREND'S SUSTAINABILITY STRATEGY

Softrend's vision of sustainability relies on three principles, originating from **United Nations' Sustainable Development Goals**.

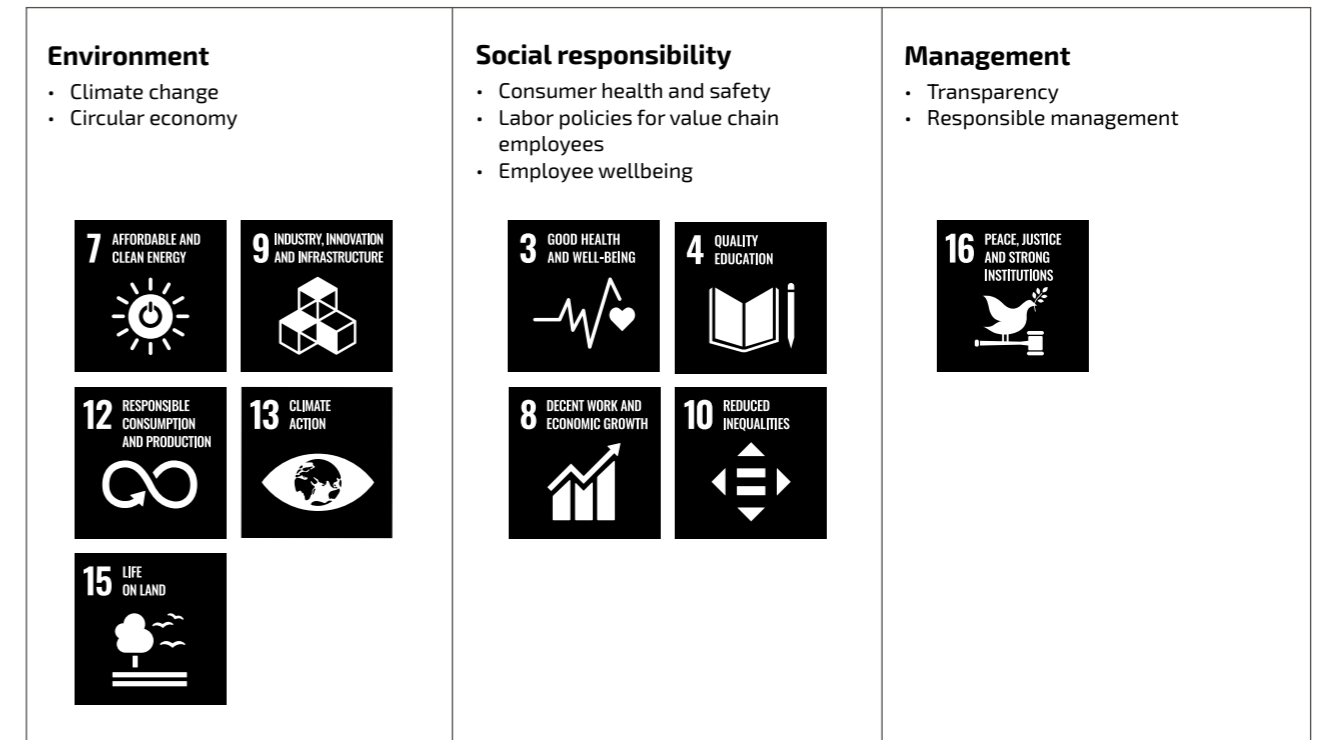

## ALREADY PART OF OUR DAILY PRACTICES

### Made to order

We prevent excess stock by producing only what is needed.

### Circular product design

We design all new products for longevity. Easy to disassemble, they can be repaired, refreshed, and ultimately recycled.

### Smart material choices

We encourage our customers to choose durable materials by offering them as standard. More and more are also recyclable.

### Minimizing waste

Following ISO 14001:2015, we reduce waste, reuse what we can, and pass the rest to our partners.

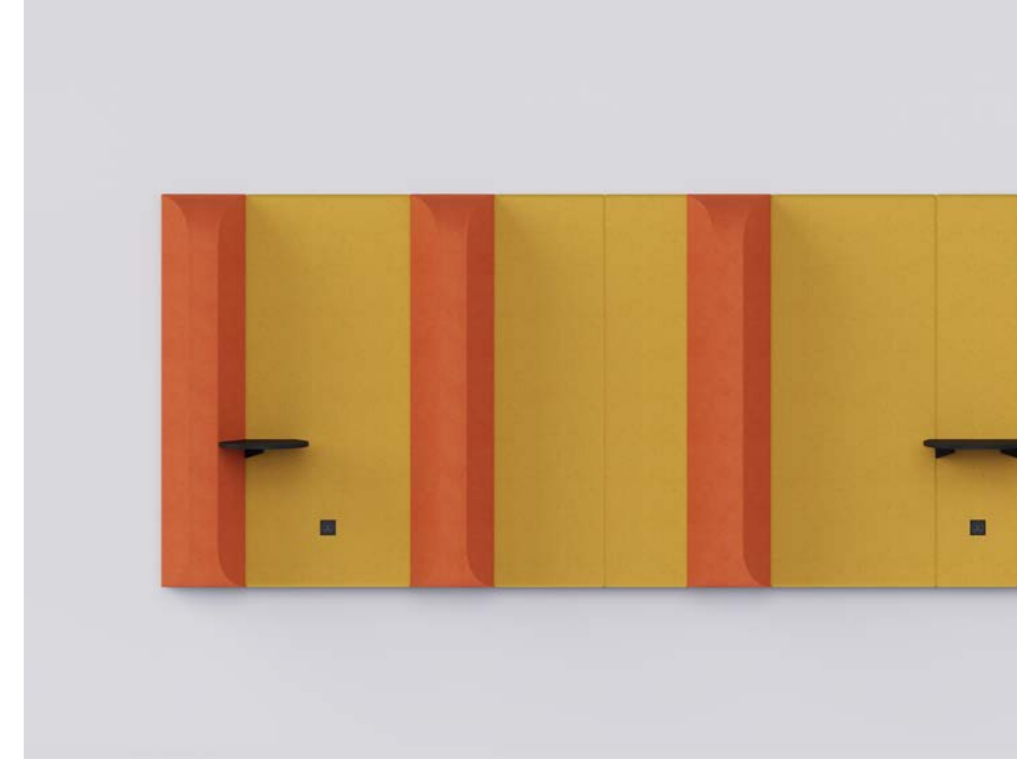

A great example of circular design is the Hover soft leaning wall – its top layers slide easily together and apart, making it simple to replace worn components.



## WHERE ARE WE GOING?

### **More eco-labelled products**

Building on the success of the Meeter series, which already carries the EU Ecolabel, we plan to certify at least ten more products or product lines by the end of 2026.

### **Improved recycling**

We will increase the use of renewable and recycled materials in our products.

### **Circular economy products**

All future products will follow circular design principles, and we will update most existing designs accordingly.

### **More sustainable packaging**

We will prioritize recyclable transport packaging and reduce plastic use.

### **Enhanced governance & business ethics**

We ensure a safe, supporting work environment while maintaining ethical and transparent business practices.



## EU ECOLABEL AND OUR PRODUCTS

The EU Ecolabel guarantees that a product is made in an environmentally and health-friendly way, has a long lifespan, and can be safely recycled. We are applying for Ecolabels for our products to help customers make more sustainable choices.

### Environment

The raw wood, cork, bamboo, or rattan used in Ecolabelled products comes from sustainably managed forests.

### Health

Ecolabelled furniture is produced without the use of hazardous chemicals, ensuring safety for everyone who comes into contact with it – both during production and use.

### Warranty

Ecolabelled products come with a long manufacturer's guarantee, reflecting their high quality and exceptional durability.

### Sustainability

Ecolabelled furniture is easy to dismantle, repair, and refresh – for example, by replacing the fabric and foam. This process further extends the product's lifespan.

### Ecolabelled fabrics

Intuit offers a range of over 1,000 fabrics, many of which carry the Ecolabel. These 19 fabrics, each with distinctive looks and versatile characteristics, come from various manufacturers and are divided into multiple price categories.

### FSC certified wood

We already use 90% FSC-certified wood in the production of Intuit's products. This certification ensures that the wood is produced with equal regard for both the environment and economic viability.



Camira Oceanic fabric range is crafted from 100% recycled polyester and plastic sourced from marine debris.

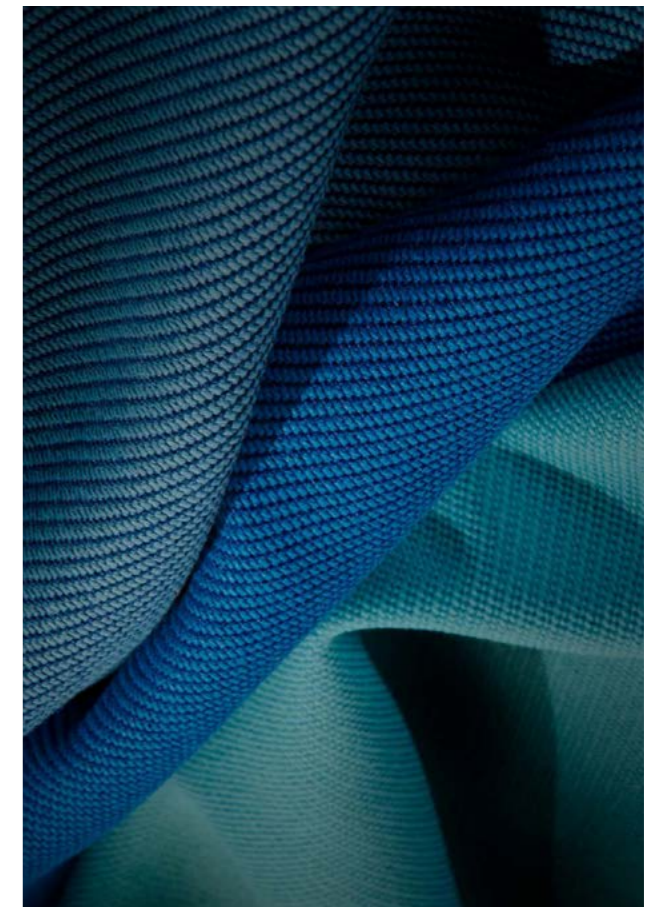

# SOUND-ABSORBING FURNITURE

Public space and open offices often have problems with resonance, meaning that sounds reverberate for too long. Sound waves cannot move freely in a closed room and bounce off the structure of the room. Some of the sound is absorbed by surfaces, while some reflects from them.

Monitoring sound absorption and achieving the recommended reverberation duration is one of the principal tasks in the acoustic design of rooms. Acoustic absorption means that sound does not reflect off a material after reaching it. That is also the principle of designing furniture with acoustic properties: furniture has to absorb the sound that would otherwise reflect back and contribute to unwelcome noise.

Creating a more pleasant environment requires us to dampen all kinds of different sounds, such as fans, people's footsteps, conversations and phone calls.

## Acoustic August

The entire August series is designed to improve office acoustics which makes it a perfect choice for an intuitive workplace. August product series gives you more absorption area in the room, e.g. better sound and less reverberance. A less reverberant room gives you better speech quality and less noise in the work environment.

The August products are rated at the highest Class A for sound attenuation. This means that they offer noise reduction equivalent to covering additional square meters of a room with 100% sound-absorbing material. The specific amount of square meters covered depends on the surface area of the chosen August model.

THE AUGUST PRODUCTS ARE RATED  
AT THE HIGHEST CLASS A  
FOR SOUND ATTENUATION



### Equivalent absorption area per object (m<sup>2</sup>Sab / object)

For example, the calculated sound absorption value for the August 2.5-S/H3 sofa model is 4.8m<sup>2</sup>/sab. This is comparable to completely covering an area of 4.8 m<sup>2</sup> with a material that absorbs 100% of sound. In practical terms, one August 2.5-S/H3 sofa provides the same noise reduction as about 12-13 sound absorber walls, each 50mm thick and covered with cloth or felt, measuring 600x600 mm.

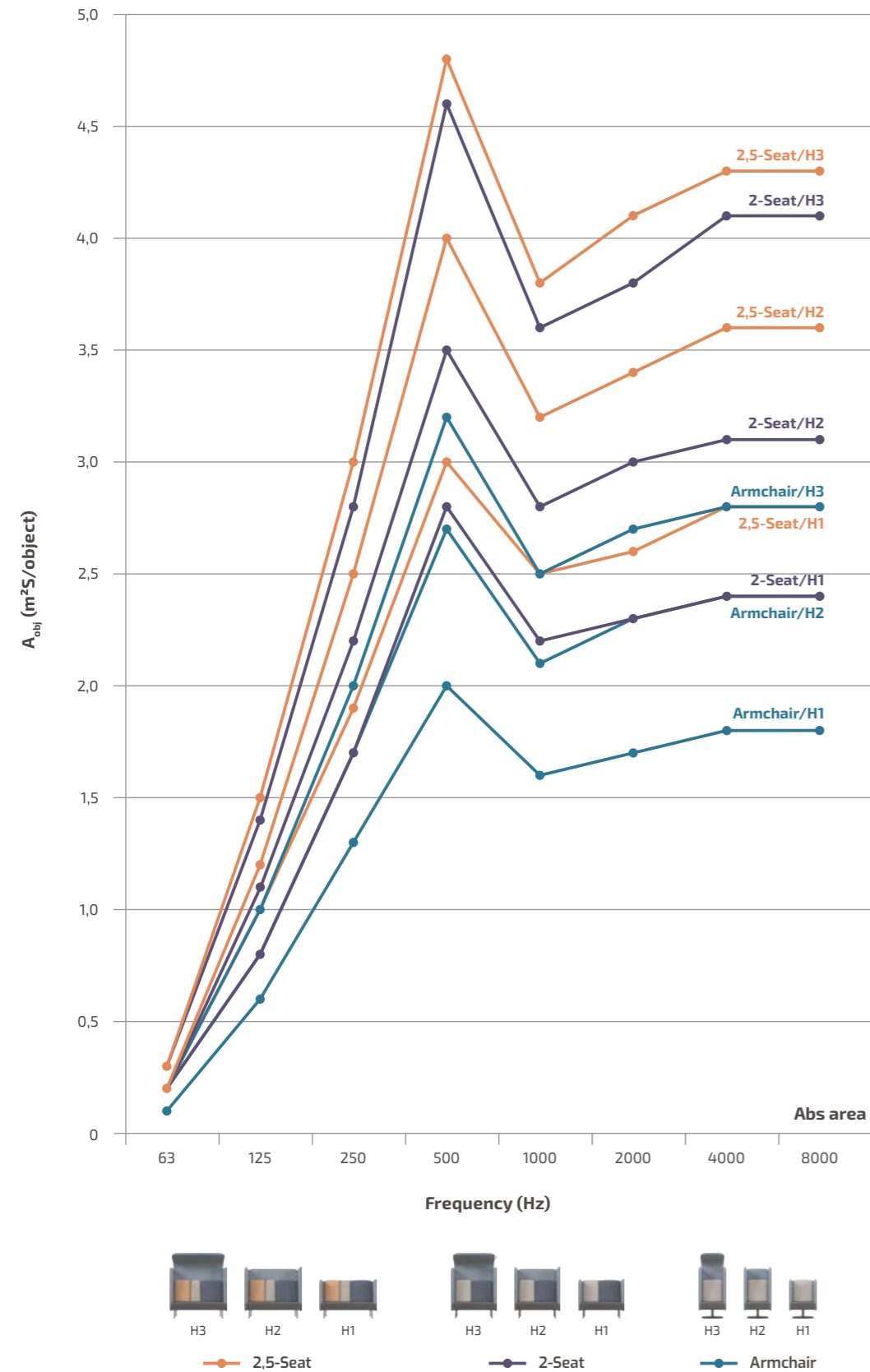

### Equivalent absorption area per object (m<sup>2</sup>Sab / object)

For example, the calculated sound absorption value for the August Workbay 2.5-S/H3 model is 10.7m<sup>2</sup>/sab. This is comparable to completely covering an area of 10.7 m<sup>2</sup> with a material that absorbs 100% of sound. In practical terms, one August Workbay 2.5-S/H3 provides the same noise reduction as about 29-30 sound absorber walls, each 50mm thick and covered with cloth or felt, measuring 600x600 mm.

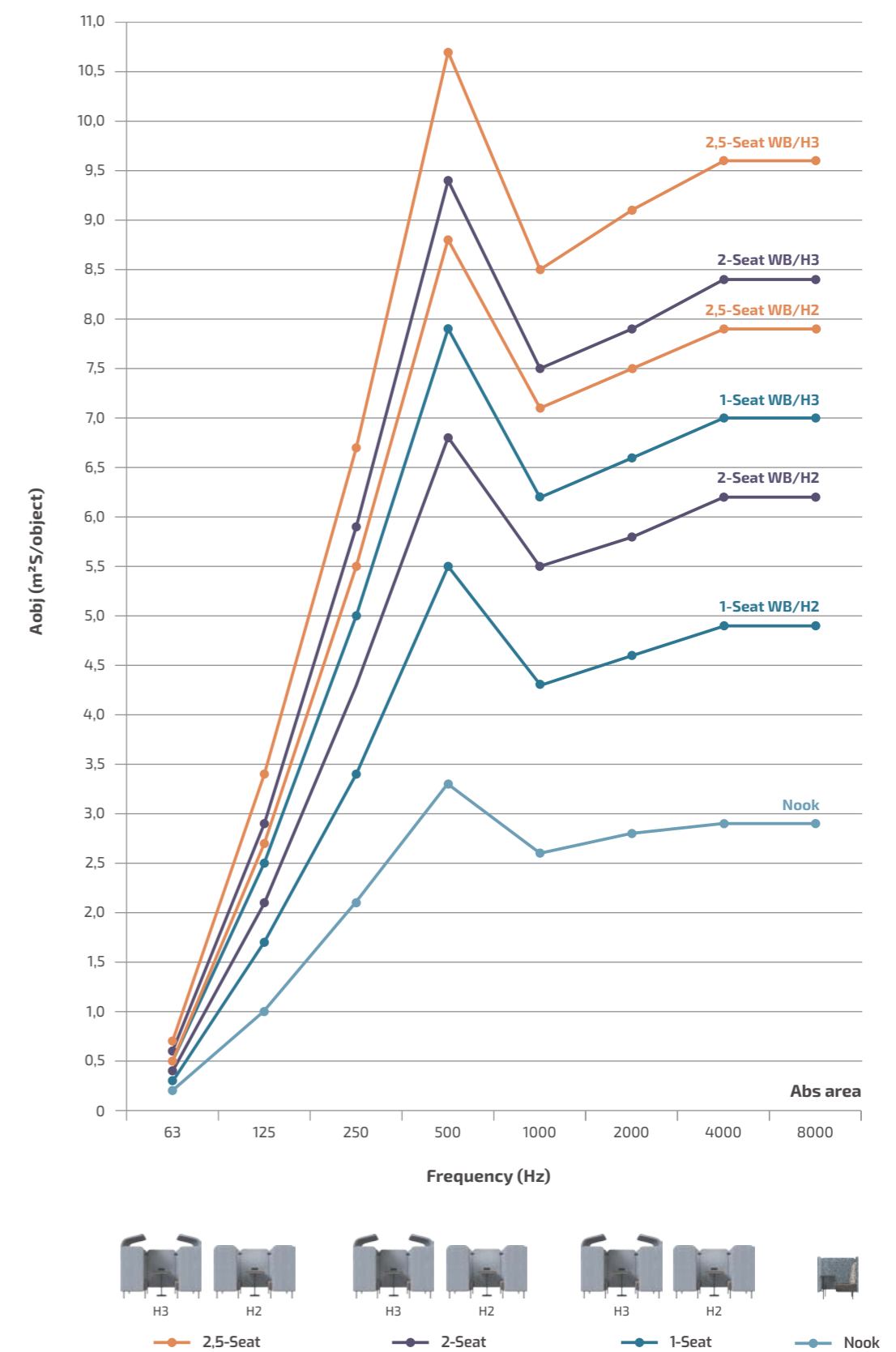

# August

Available at  
**pCon**  
PLANNER

## Sound-absorbing sofa and armchair

Design: Pent Talvet, Iseasi

The timeless and playful August series ranks among Intuit's TOP 3 popular products. We designed the August range to perfectly address the room acoustics issues which makes it a perfect choice for an intuitive workplace. Get away from the constant distractions, and quieten the noise when it's all too much.

With sound-absorbing walls, August gives you a private oasis within even the noisiest of surroundings, and the different height options make August versatile enough for conversations in your Social Zone, or focused individual work in your Concentration Zone.



Social Zone



Concentration Zone

Encourage focus and seclusion

Host private meetings

Divide your space organically

Cut down on background noise

## PRODUCT INFORMATION

### Versions

Available in 3 different heights and 3 different sizes

### Acoustics

Sound absorption class A

### Legs

Available with regular legs and 360° swivel base (only for armchair)

### Accessories

Tables to add functionality to the seating area

### Electrical outlet

Under the seating attached to the frame

### Warranty

5 years

### Sustainability

Embraces the principles of circular design

### Test & Certification

- L1 European Standard strength, durability and safety certificate
- Acoustic absorption test - Class A



## STANDARD MATERIALS

### Frame

Solid wood and plywood

### Seat & backrest

Durable HR foam; fire retardant HR foam on request; fixed seat and back cushions

### Legs

Solid oak / Powder-coated metal

### Tables

Matt high-pressure laminate, or mass-colored wood fibreboard top with matt powder-coated metal legs

### Fabric upholstery

The cover material is not removable  
Sides and rear wall of H3 models can exclusively be covered with felt fabric only

Choose any fabric from **Intuit Standard Fabric Collection**

### Additional information

As part of after-sales service we offer the change of cover fabric and all other components if needed

Vaisala office in Helsinki, Finland. Photo: Hannakaisa Pekkala





## LEGS



Solid oak legs, stained and varnished; anti-slip soles







Matt powder-coated metal legs; anti-slip soles

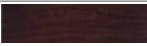

360° swivel base, powder-coated metal (only for armchair)

### Solid oak

Whitened	
Natural	
Wenge	
Black	

### Powder-coated metal

Jet Black RAL 9005	
--------------------	---

Other finishing options available on request.



Mustamäe State Gymnasium in Tallinn, Estonia. Photo: Märt Lillesiim

## TABLES







Aide table



August side table



### Aide tabletop

#### High-pressure laminate

Alpine White Egger W1100 PM	
Soft Black Egger U899 PM	
Stone Green Egger U665 PM	
Garnet Red Egger U399 PM	

### Aide table legs

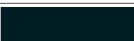
#### Powder-coated metal

Signal White RAL 9003	
Jet Black RAL 9005	
Tarpaulin Grey RAL 7010	
Black Red RAL 3007	

Other finishing options available on request.

### August tabletop

#### High-pressure laminate, plywood edge

Black	
-------	---

#### Mass-colored wood fibreboard

Grey	
Black	

### August table frame

#### Powder-coated metal

Jet Black RAL 9005	
--------------------	---

## ELECTRICAL OUTLET

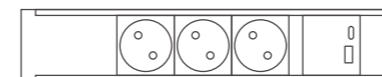

3x 220V + USB A & C

Other electrical outlet combinations available on request.

**Bachmann Power Strip**  
Color: Black

Available options DK, EU, FR, UK

## DIMENSIONS

### Armchair and sofa

Seat depth: 48 cm / Seat height: 45 cm

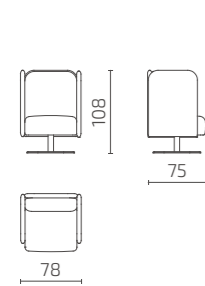

**S101-S1H1 (J-39)**

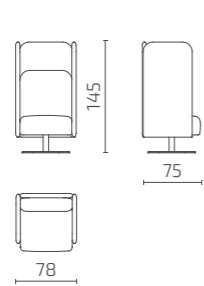

**S101-S1H2 (J-39)**

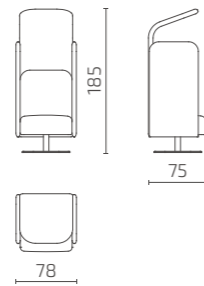

**S101-S1H3 (J-39)**

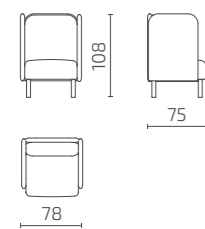

**S101-S1H1**

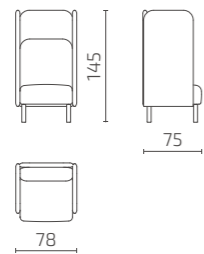

**S101-S1H2**

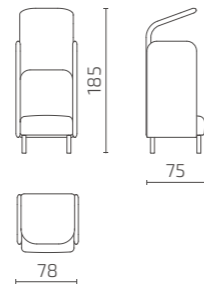

**S101-S1H3**

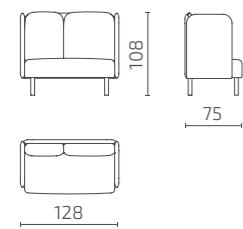

**S101-S2H1**

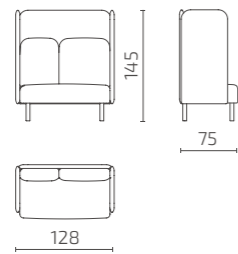

**S101-S2H2**

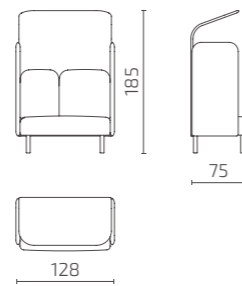

**S101-S2H3**

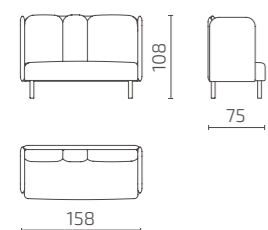

**S101-S25H1**

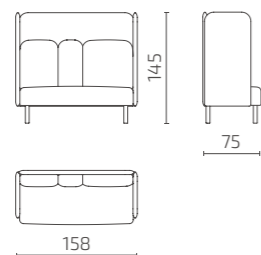

**S101-S25H2**

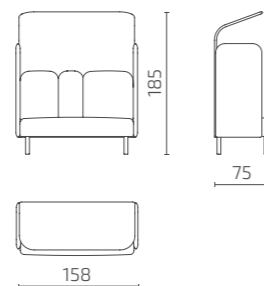

**S101-S25H3**

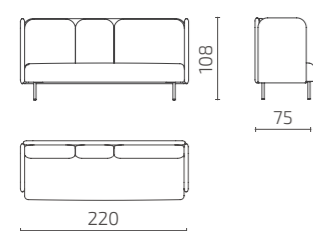

**S101-S3H1**

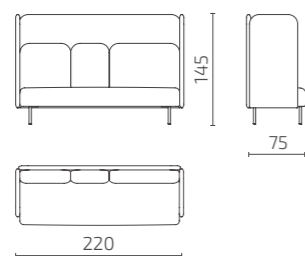

**S101-S3H2**

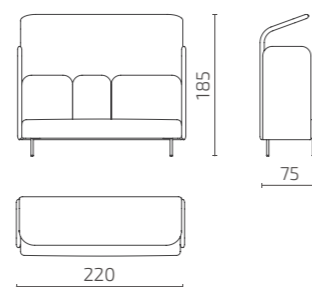

**S101-S3H3**

### Tables

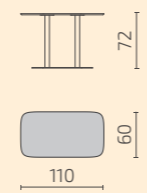

**S128-T1M**  
AIDE table

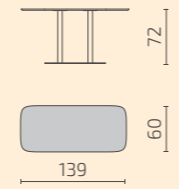

**S128-T3M**  
AIDE table

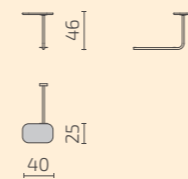

**S101-T2**  
AUGUST table



Armchair H1

Armchair H2

Armchair H3



Sofa 2-Seat / H1

Sofa 2-Seat / H2

Sofa 2-Seat / H3



Sofa 2,5-Seat / H1

Sofa 2,5-Seat / H2

Sofa 2,5-Seat / H3



Sofa 3-Seat / H1

Sofa 3-Seat / H2

Sofa 3-Seat / H3

Co-working space NUUUORK at Berlin Airport, Germany. Photo: Ariane Brille

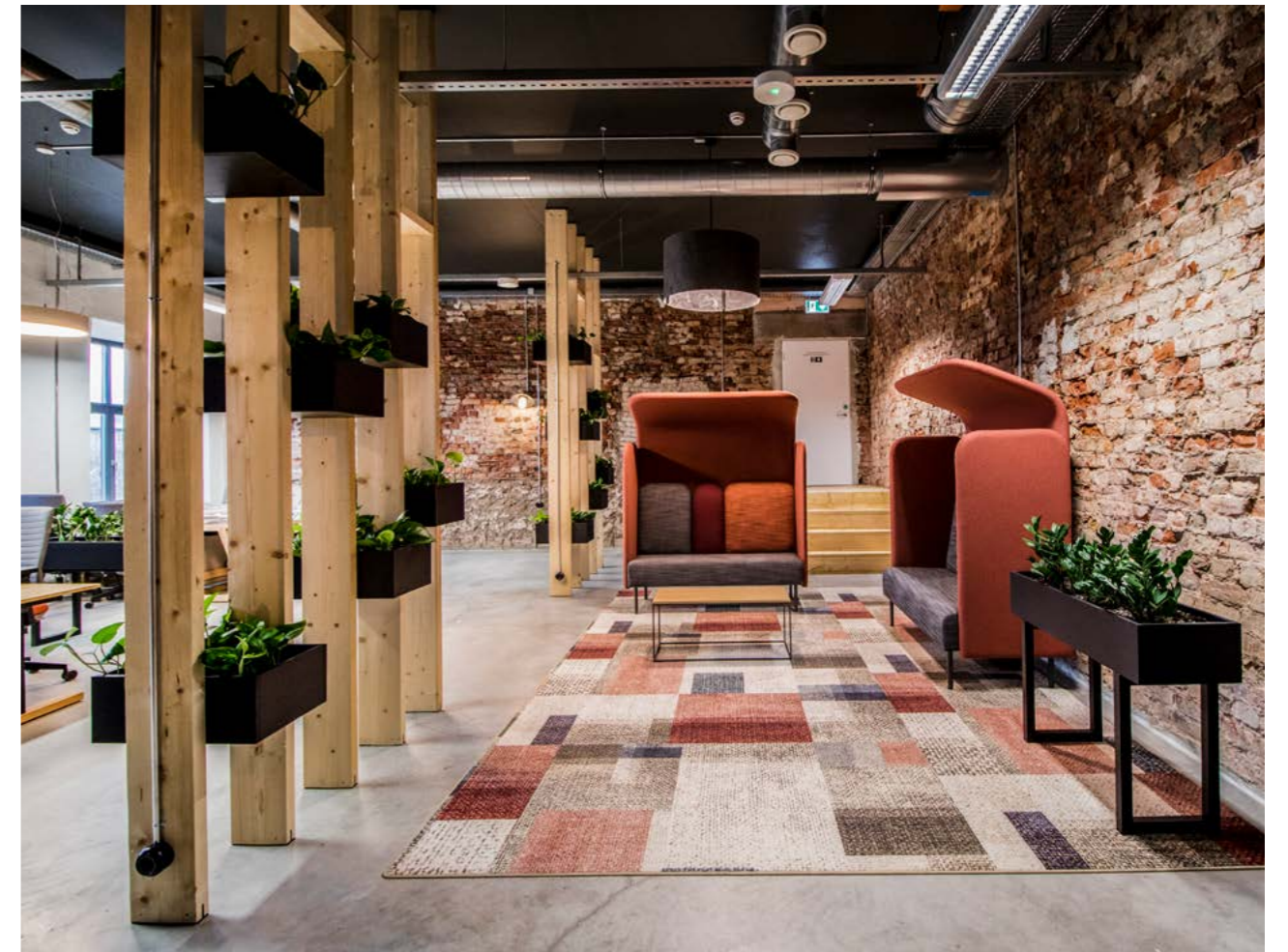

RebelRoam office in Tallinn, Estonia. Photo: Kristiina Vasar

# August Workbay

Available at  
**pCon**  
 PLANNER

## Sound-absorbing workstation

Design: Pent Talvet, Iseasi

Looking for the perfect spot to have that important conversation? The August sofa set provides an easy solution for creating a workbay where you can go to get some privacy or have meetings. The August Workbay is an integral part of your Concentration Zone, providing an opportunity to step away from the noise, and find the focus you need.

The only thing it takes is to connect two August sofas or armchairs with a partition wall. Sound-absorbing qualities make it easy to carve out a space of peace and quiet within an open-plan office. Distraction-busting high sides with sound-absorbing qualities make it easy to carve out a space of peace and quiet within an open-plan surroundings.



Collaboration Zone



Concentration Zone

- Divide your space organically
- Cut down on background noise
- Hold your own private meeting
- Give the option of focus and seclusion

## PRODUCT INFORMATION

### Versions

Available in 2 different heights and 4 different sizes

### Acoustics

Sound absorption class A

### Accessories

Additional tables to add functionality to the seating area

### Electrical outlet

Integrated in the PC and TV wall

### Warranty

5 years

### Sustainability

Embraces the principles of circular design

### Test & Certification

- L1 European Standard strength, durability and safety certificate
- Acoustic absorption test - Class A



## STANDARD MATERIALS

### Frame

Solid wood and plywood

### Seat & backrest

Durable HR foam; fire retardant HR foam on request; fixed seat and back cushions

### Wall fastenings

Powder-coated metal

### Legs

Solid oak / Powder-coated metal

### Tables

Matt high-pressure laminate, or mass-colored wood fibreboard top with matt powder-coated metal legs

### Fabric upholstery

The cover material is not removable  
 Sides and rear wall of H3 models can exclusively be covered with felt fabric only

Choose any fabric from **Intuit Standard Fabric Collection**

### Additional information

As part of after-sales service we offer the change of cover fabric and all other components if needed



## LEGS







Solid oak legs, stained and varnished; anti-slip soles



Matt powder-coated metal legs; anti-slip soles

### Solid oak

Whitened	
Natural	
Wenge	
Black	

Other finishing options available on request.

### Powder-coated metal

Jet Black RAL 9005	
--------------------	---

## ELECTRICAL OUTLET

### Integrated in the PC wall

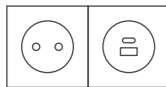

220V + USB A & C



**Berker Integro Flow**  
Color: Anthracite Matt

Available options DK, EU, FR, UK

### Integrated in the TV wall

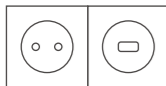

220V + HDMI



**Berker Integro Flow**  
Color: Anthracite Matt

Available options DK, EU, FR, UK

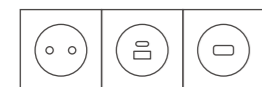

220V + USB A & C + HDMI

**Berker Integro Flow**  
Color: Anthracite Matt

Available options DK, EU, FR, UK

Other electrical outlet combinations available on request.





## TABLES



Aide cafeteria / work tables





### Aide tabletop

#### High-pressure laminate

Alpine White Egger W1100 PM	
Soft Black Egger U899 PM	
Stone Green Egger U665 PM	
Garnet Red Egger U399 PM	

### Aide table legs

#### Powder-coated metal

Signal White RAL 9003	
Jet Black RAL 9005	
Tarpaulin Grey RAL 7010	
Black Red RAL 3007	

Other finishing options available on request.



August table with plywood edge

### August tabletop

#### High-pressure laminate, plywood edge

Black	
-------	---

#### Mass-colored wood fibreboard

Grey	
Black	

### August table frame

#### Powder-coated metal

Jet Black RAL 9005	
--------------------	---

Payfit office in Paris, France

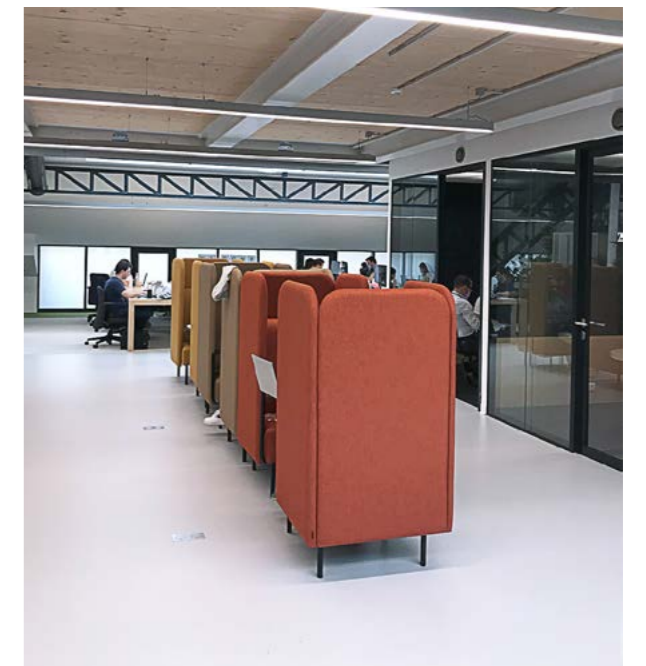

## DIMENSIONS

### Workbay

Seat depth: 48 cm / Seat height: 45 cm

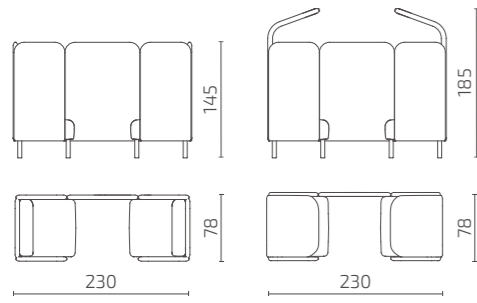

**S101-WS1H2**

**S101-WS1H3**

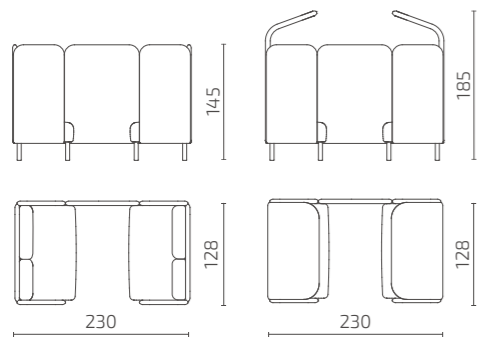

**S101-WS2H2**

**S101-WS2H3**

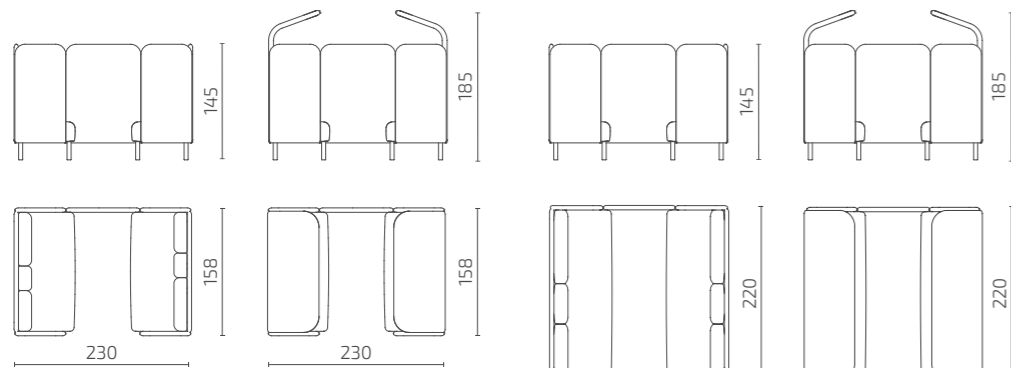

**S101-WS25H2**

**S101-WS25H3**

**S101-WS3H2**

**S101-WS3H3**

### Workbay wall

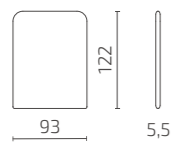

Regular wall



**S101-ELPC**  
PC integrated  
electrical outlet



**S101-ELTV**  
TV integrated  
electrical outlet

All dimensions provided in centimetres.

### Tables



**S128-T4M**  
AIDE table



**S128-T1M**  
AIDE table



**S128-T3M**  
AIDE table

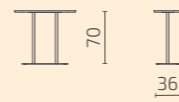

**S101-T1**  
AUGUST table

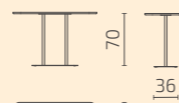

**S101-T3**  
AUGUST table



# August Nook

Available at  
**pCon**  
PLANNER

## Sound-absorbing workstation

Design: Pent Talvet, Iseasi

How do you provide a welcoming space for your hybrid workers? You need the compact 3-in-1 August Nook, with its built-in laptop size table, comfortable seat, and sound-absorbing screens.

Inviting you into a secluded spot that encourages focus and deep work, the Nook is somewhere you can slip into for an hour, or hang out in all day. Everything you need, all in one streamlined space.



Concentration Zone

Divide your space with ease

Cut down on background noise

Encourage focus and seclusion

## PRODUCT INFORMATION

### Versions

Left- or right-handed seat position

### Acoustics

Sound absorption class A

### Electrical outlet

Integrated in the table top

### Warranty

5 years

### Sustainability

Embraces the principles of circular design

### Test & Certification

- L1 European Standard strength, durability and safety certificate
- Acoustic absorption test - Class A



## STANDARD MATERIALS

### Frame

Solid wood and plywood

### Seat & backrest

Durable HR foam; fire retardant HR foam on request; fixed seat and back cushions

### Legs

Powder-coated metal

### Tables

Matt high-pressure laminate, or mass-colored wood fibreboard top with matt powder-coated metal frame

### Fabric upholstery

The cover material is not removable

Choose any fabric from **Intuit Standard Fabric Collection**

### Additional information

As part of after-sales service we offer the change of cover fabric and all other components if needed

Bornego College in Netherlands

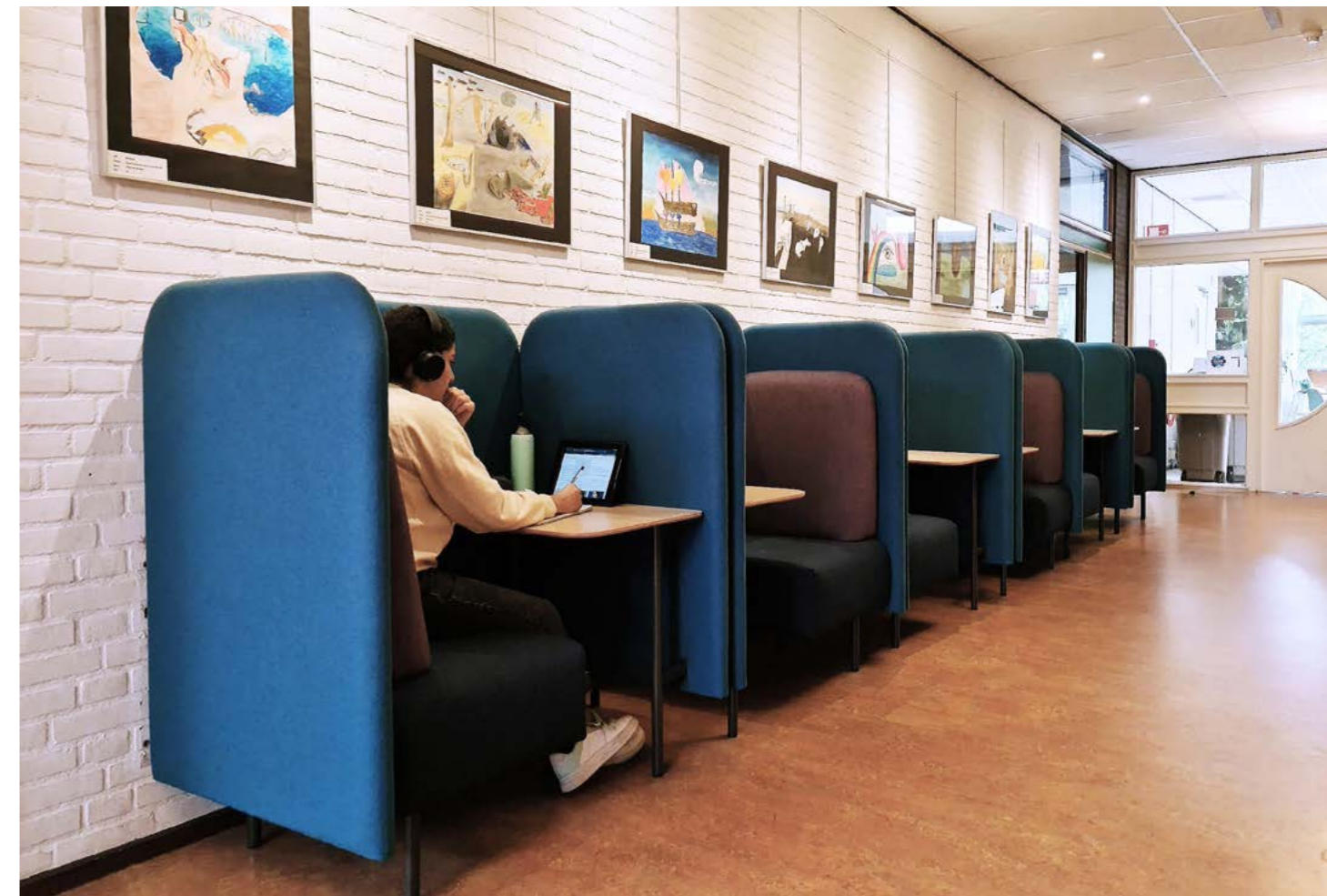

## FINISHING OPTIONS

### Legs

#### Powder-coated metal

Jet Black RAL 9005



### Tabletop

#### High-pressure laminate, plywood edge

Black



#### Mass-colored wood fibreboard

Grey



Black



### Table frame

#### Powder-coated metal

Jet Black RAL 9005



Other finishing options available on request.

## ELECTRICAL OUTLET



220V

**Powerdot Mini 50**  
Color: Black Matt

Available options CH, EU, FR



220V + USB A

**Powerdot Compact 61**  
Color: Black Matt

Available options EU, FR, UK

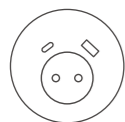

220V + USB A & C

**Powerdot 16**  
Color: Black Matt

Available options DK, EU, FR

Other electrical outlet combinations available on request.



## DIMENSIONS

Seat depth: 48 cm / Seat height: 45 cm

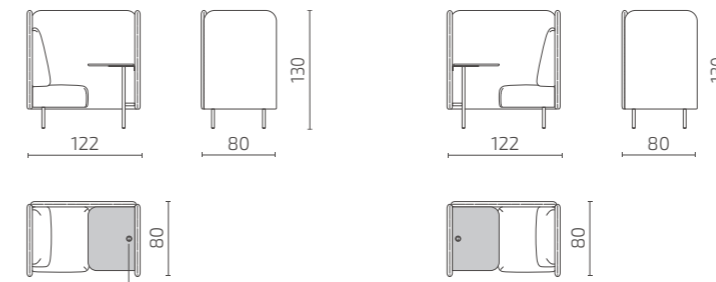

Integrated electrical outlet  
in the table top

S101-NS1L

S101-NS1R

All dimensions provided in centimetres.





# August Wall

Available at  
**pCon**  
PLANNER

## Sound-absorbing wall panelling and bench

Design: Pent Talvet, Iseasi

Soft August Wall panels with a separate pouffe add a playful touch to the August range. Sound-absorbing panels help improve the acoustic properties of open rooms. Use the August Wall and bench combination to create areas of circulation, where colleagues can have encounters that brighten their day.

## PRODUCT INFORMATION

### Versions

Available in 2 different modules

### Warranty

5 years

### Sustainability

Embraces the principles of circular design

### Test & Certification

L1 European Standard strength, durability and safety certificate



## STANDARD MATERIALS

### Frame

Solid wood and plywood

### Seat & backrest

Durable HR foam; fire retardant HR foam on request

### Legs

Solid oak / Powder-coated metal

### Fabric upholstery

The cover material is not removable

Choose any fabric from **Intuit Standard Fabric Collection**

### Additional information

As part of after-sales service we offer the change of cover fabric and all other components if needed



Welcome Zone



Social Zone

Make your visitors feel at home

Make connections with colleagues

Cut down on background noise



## LEGS



Solid oak legs, stained and varnished; anti-slip soles



Matt powder-coated metal legs; anti-slip soles

### Solid oak

Whitened

Natural

Wenge

Black

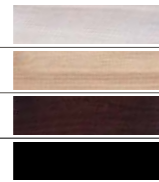

### Powder-coated metal

Jet Black RAL 9005



Other finishing options available on request.

## PRODUCT CONSTRUCTION

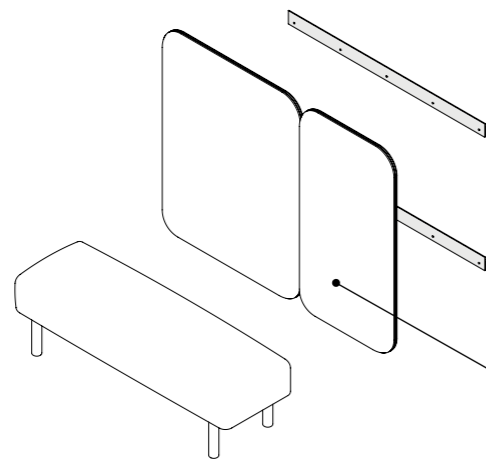
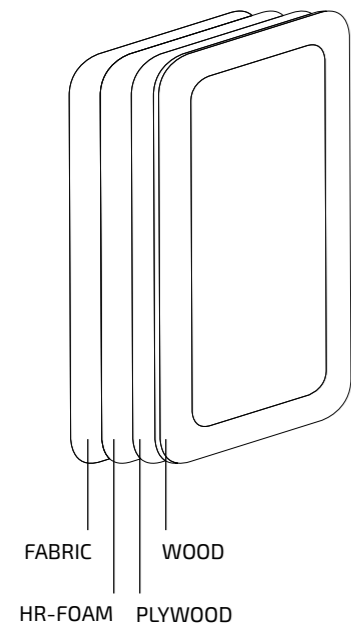

August Wall is a separate panel to be installed on the wall

## DIMENSIONS

**August bench**  
Seat depth: 48 cm

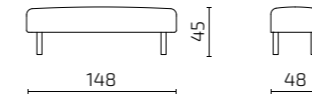

**S101-F25**

**Wall panel**

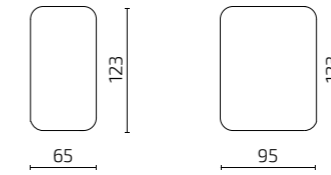

**S101-WS**

**S101-WM**

All dimensions provided in centimetres.



# Ben

Available at  
**pCon**  
PLANNER

## Soft office sofa

Design: Intuit design team

Sometimes the best business conversations happen away from the desk. Make sure your Social Zone sparks inspiration with the Ben Sofa. With versatile modules, you can create a piece of furniture that perfectly fits your space. And with Ben's springy softness your team will enjoy building connections over coffee.

Superior in design and comfort to the breakroom chairs you're used to, Ben shows your team how much you value their comfort and wellbeing. Put the finishing touches to your Social Zone with this inviting sofa.

## PRODUCT INFORMATION

### Versions

Available in many different modules with and without armrests and 4 different pouffe sizes

### Accessories

Additional pillows, two sizes available

### Warranty

5 years

### Sustainability

Based on principles of the circular economy

### Certification



## STANDARD MATERIALS

### Frame

Solid wood and plywood, zigzag springs

### Seat and backrest

Durable HR foam; fire retardant HR foam on request

### Pillows

Feather or fibre filling

### Fabric upholstery

The cover fabric is not removable

Choose any fabric from **Intuit Standard Fabric Collection**

### Additional information

As part of after-sales service we offer the change of cover fabric and all other components if needed



Welcome Zone



Social Zone

Take a break

Make connections with colleagues

Make your visitors feel at home

Grab moments of rest

Total Jobs office in Portsmouth, UK. Photo: Soren Kristensen

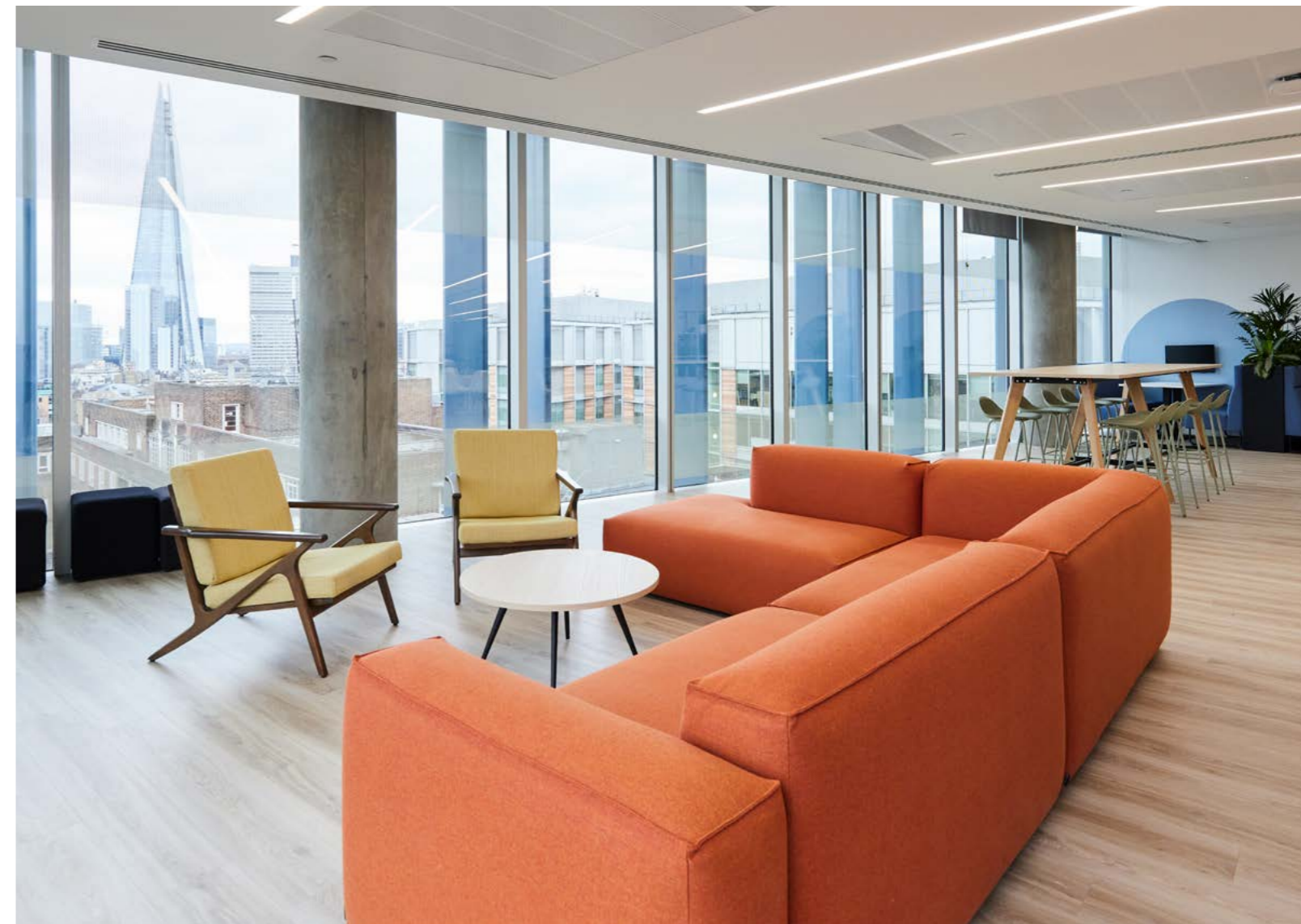

## DIMENSIONS

### Modules

Seat depth: 58 cm / Seat height: 37 cm

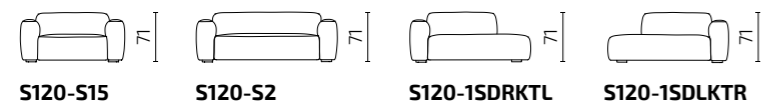
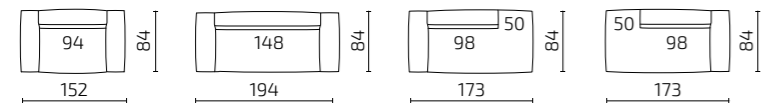

**S120-S15**    **S120-S2**    **S120-1SDRRTL**    **S120-1SDLKTR**

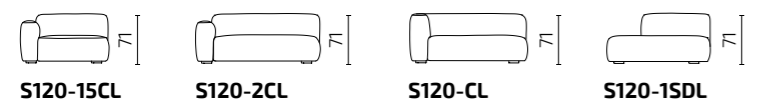
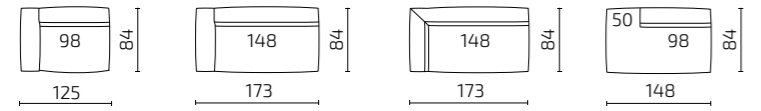

**S120-15CL**    **S120-2CL**    **S120-CL**    **S120-1SDL**

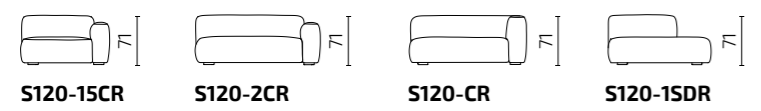
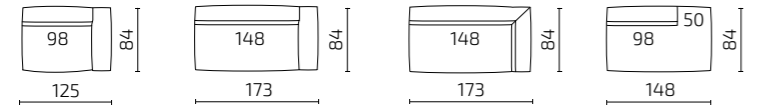

**S120-15CR**    **S120-2CR**    **S120-CR**    **S120-1SDR**

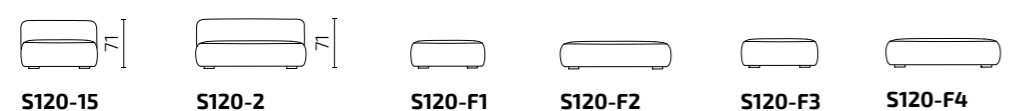
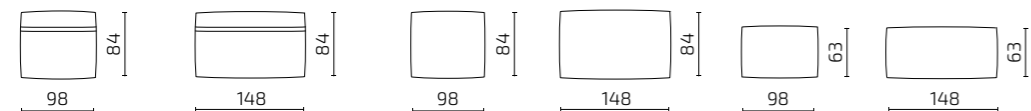

**S120-15**    **S120-2**    **S120-F1**    **S120-F2**    **S120-F3**    **S120-F4**

All dimensions provided in centimetres.

### SAMPLE COMBINATIONS

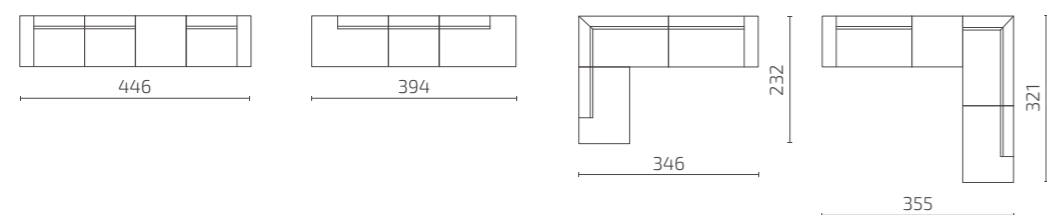
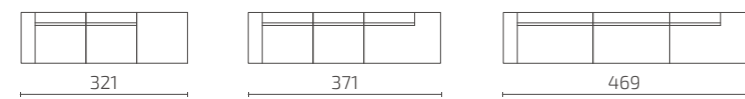
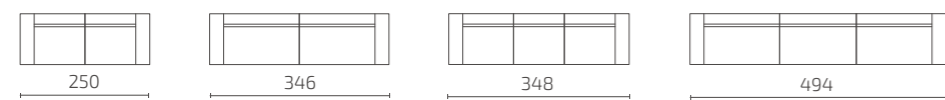

### Pillows

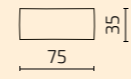

**S120-P1**

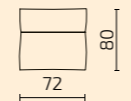

**S120-P2**



Separate module with armrest (left)



2-Seat with armrest (left) / Corner module (left) / Extended seat module (right)



2 x Footrest 4 / Extended seat module (right)



1.5-Seat with armrest (left) / 1.5-Seat with armrest (right)



Totaljobs office in Portsmouth, UK. Photo: Soren Kristensen

# Don

Available at  
**pCon**  
PLANNER

## Soft office sofa

Design: Intuit design team

While the lounge couch Ben serves as the focal point of the Social Zone, creating a comfortable space for colleagues to take a break from work, its larger counterpart, Don, elevates these breaks to a whole new level.

Don is as springy and as elegantly designed as Ben, but with a slightly deeper seating area, which adds a luxurious look and makes things more comfortable. Now everyone can get cosy and enjoy lying down, including four-legged members of the office.

## PRODUCT INFORMATION

### Versions

Available in many different modules with and without armrests and 3 different pouffe sizes

### Accessories

Additional pillows, two sizes available

### Warranty

5 years

### Sustainability

Based on principles of the circular economy

### Certification



## STANDARD MATERIALS

### Frame

Solid wood and plywood, zigzag springs

### Seat and backrest

Durable HR foam; fire retardant HR foam on request

### Pillows

Feather or fibre filling

### Fabric upholstery

The cover fabric is not removable

Choose any fabric from **Intuit Standard Fabric Collection**

### Additional information

As part of after-sales service we offer the change of cover fabric and all other components if needed



Welcome Zone



Social Zone

Offer a spacious and comfortable seating area

Make guests feel at home

A great place to befriend colleagues

Lithuanian Railway office in Vilnius, Lithuania. Photo: Lukas Jusas

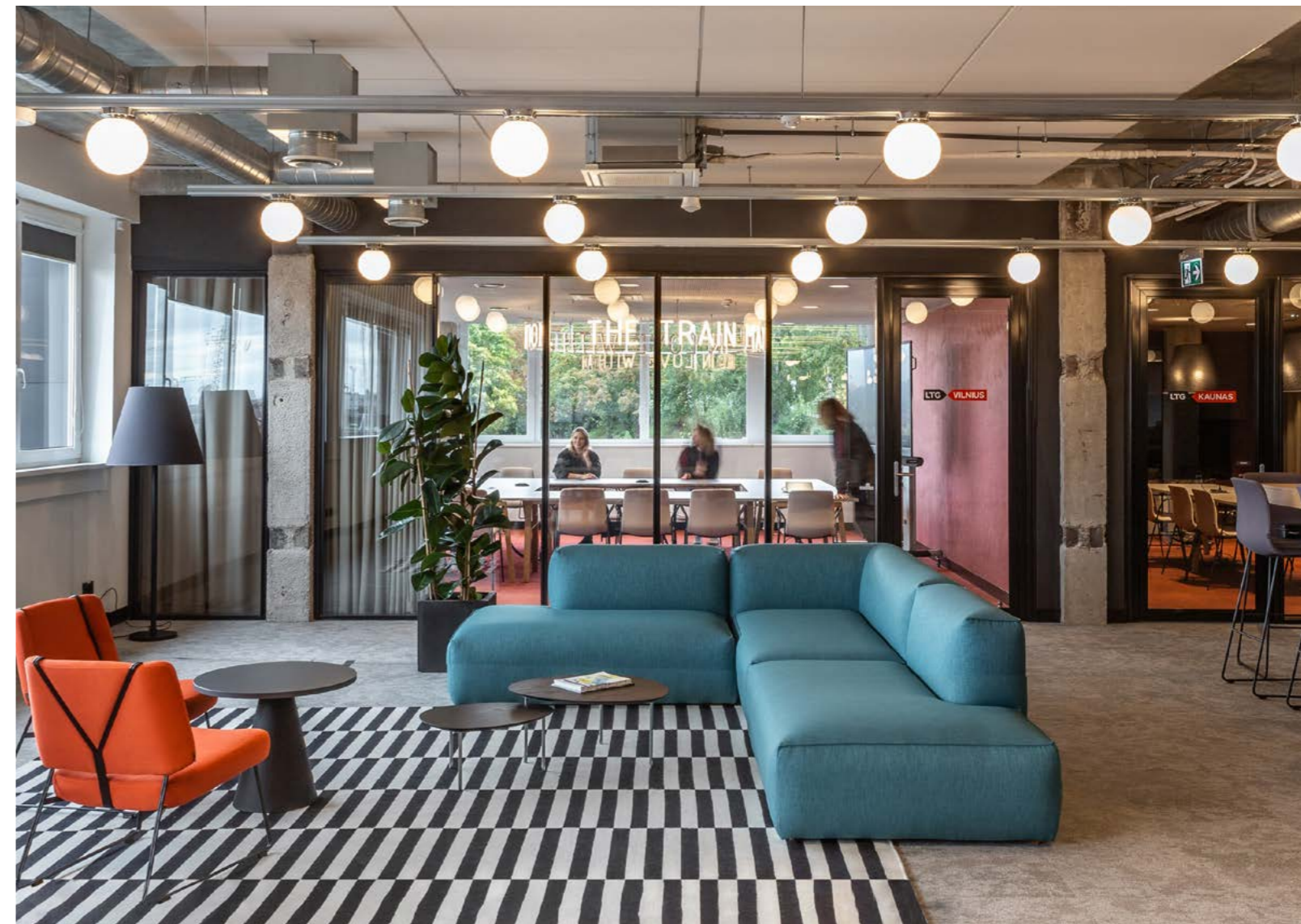

## DIMENSIONS

### Modules

Seat depth: 72 cm / Seat height: 37 cm

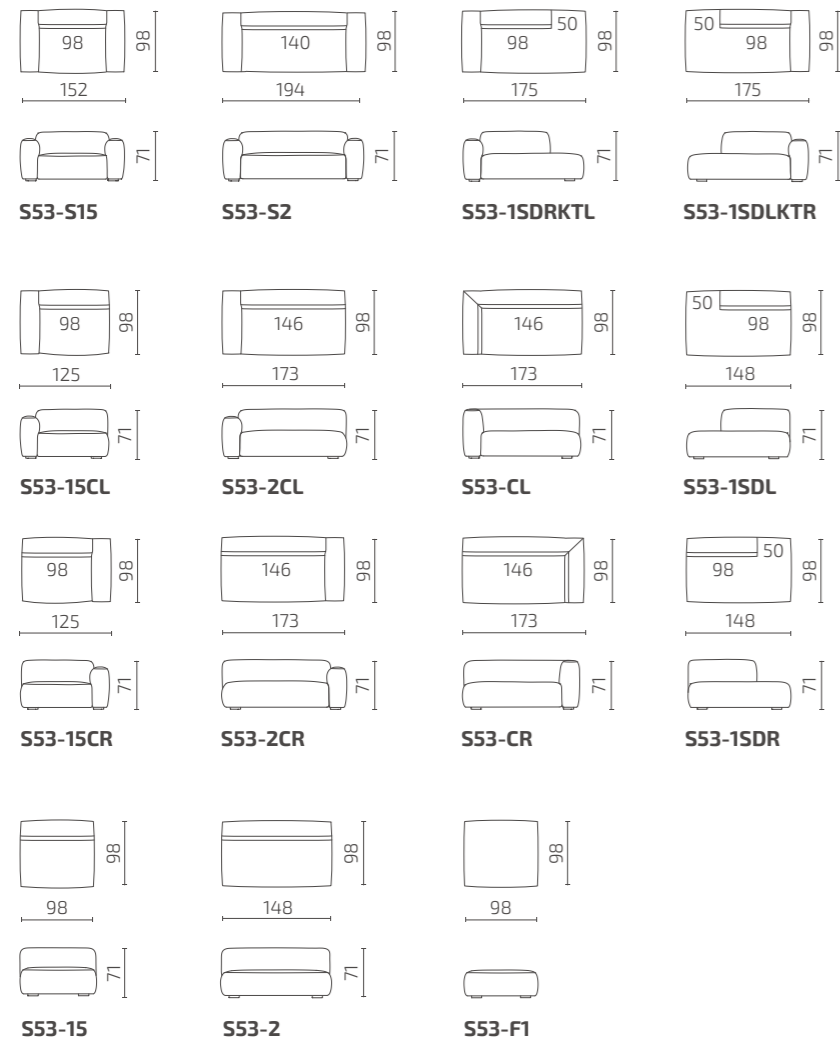

All dimensions provided in centimetres.

### SAMPLE COMBINATIONS

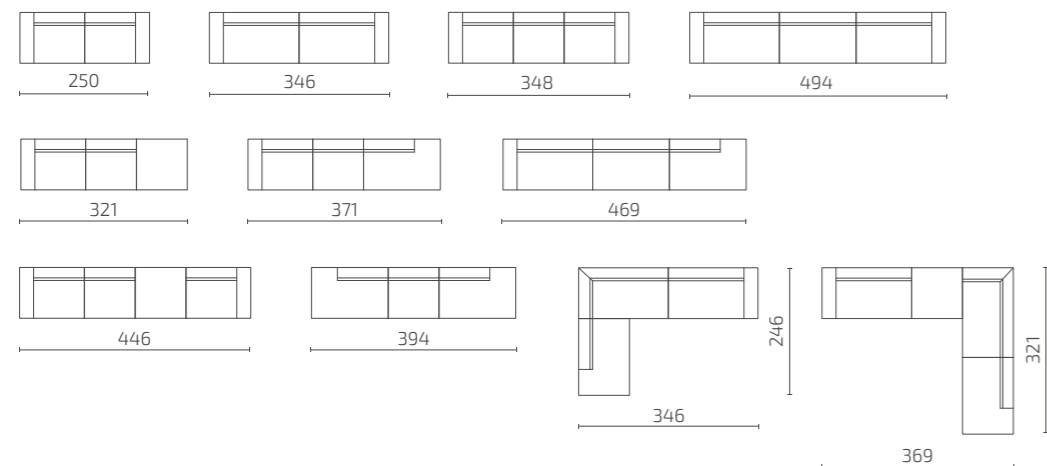

### Pillows

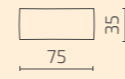

**S53-P1**

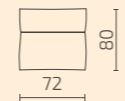

**S53-P2**



1.5-Seat with armrest (left) / 1.5-Seat



1.5-Seat with armrest (left) / 1.5-Seat / Footrest



1.5-Seat with armrest (left) / Extended seat module (right)



Separate module with armrest (left)



1.5-Seat with armrest (left) / 1.5-Seat with armrest (right)



2-Seat with armrest (left) / 2-Seat with armrest (right)



1.5-Seat with armrest (left) / 1.5-Seat / 1.5-Seat with armrest (right)



2-Seat / Corner module (left)



Extended seat module (left) / Corner module (left) / Extended seat module (right)

# Frankie

Available at  
**pCon**  
 PLANNER

## Work sofa

Design: Argo Tamm

The slender and versatile Frankie embodies Intuit's agile ethos. With options of a sofa, armchair, and extended bench your imagination is the only limit. The set includes an attached table: a space for a computer, mug or magazine. Find your sweet spot with Frankie.



## PRODUCT INFORMATION

### Versions

Available in many different dimensions

### Modularity

Modules can be connected together

### Accessories

Rotating attached side table to add functionality  
 Extra pillow

### Electrical outlet

Under the seating attached to the frame

### Warranty

5 years

### Sustainability

Based on principles of the circular economy

### Test & Certification

L1 European Standard strength, durability and safety certificate



## STANDARD MATERIALS

### Frame

Metal, solid wood and plywood

### Seat & backrest

Durable HR foam; fire retardant HR foam on request

### Legs

Powder-coated metal; anti-slip soles

### Table

Matt high-pressure laminate, or mass-colored wood fibreboard top with matt powder-coated metal frame

### Pillow

Feather filling

### Fabric upholstery

The cover fabric is not removable  
 Choose any fabric from **Intuit Standard Fabric Collection**

### Additional information

As part of after-sales service we offer the change of cover fabric and all other components if needed

Pipedrive office in Tallinn, Estonia



Collaboration Zone



Concentration Zone

Divide your space organically

Create focus and seclusion

Encourage rest

Host your own private meeting

## FINISHING OPTIONS

### Legs

#### Powder-coated metal

Jet Black RAL 9005



### Tabletop

#### High-pressure laminate, plywood edge

Black



#### Mass-colored wood fibreboard

Grey



Black



### Table frame

#### Powder-coated metal

Jet Black RAL 9005



Other finishing options available on request.



## ELECTRICAL OUTLET

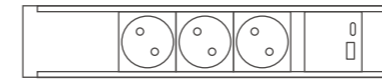

3x 220V + USB A & C

### Bachmann Power Strip

Color: Black Matt

Available options DK, EU, FR, UK

Other electrical outlet combinations available on request.



## SAMPLE COMBINATIONS



1-Seat with 2 side wall



1-Seat with 3 side wall



2-Seat with double opposite 2 side walls



2-Seat with double 2 side walls



2-Seat with double 2/3 side walls



2-Seat with double 3 side walls





## DIMENSIONS

### Modules

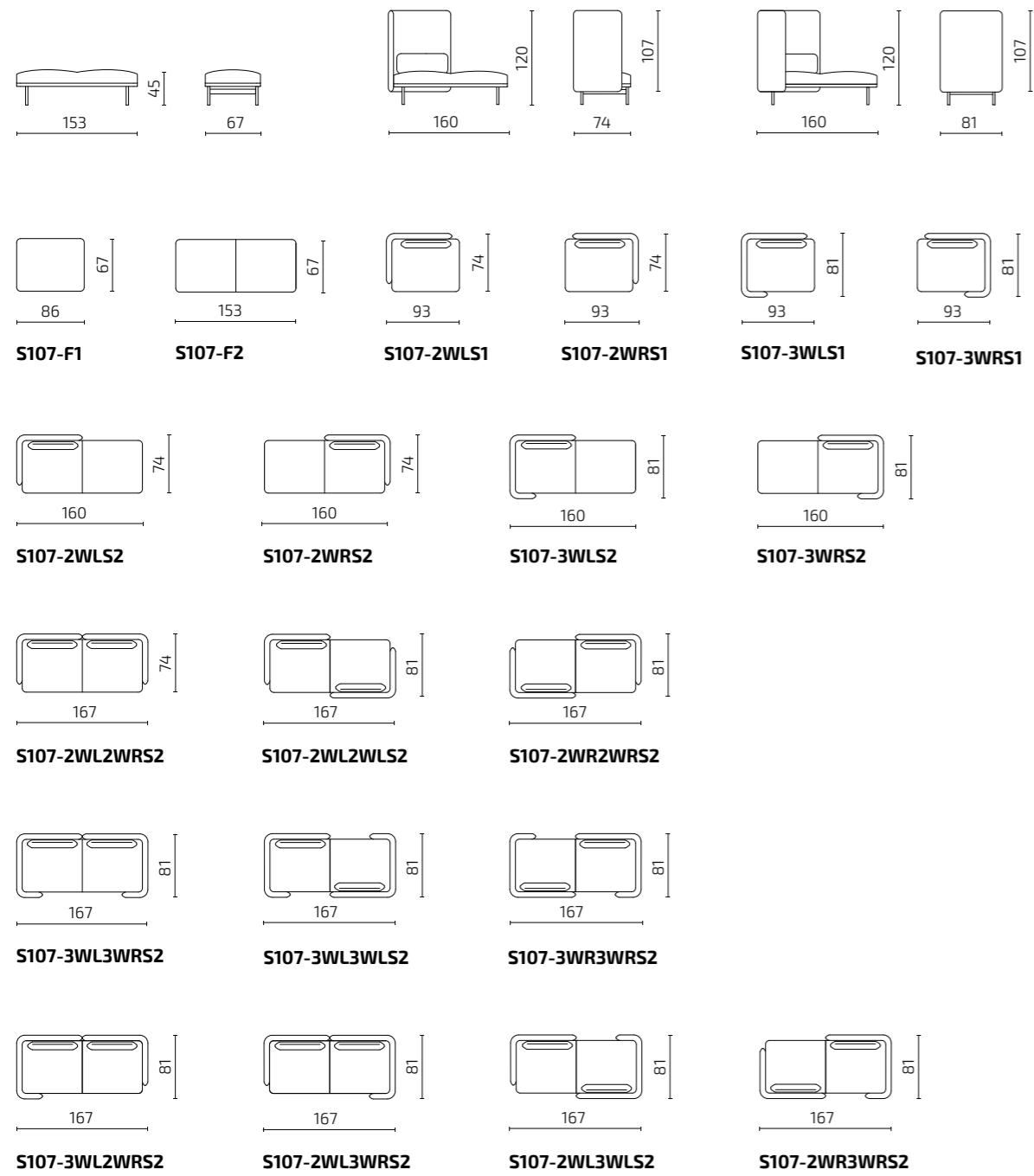

### Table

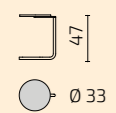

S107-T330

### Pillow

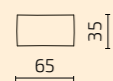

S107-DP

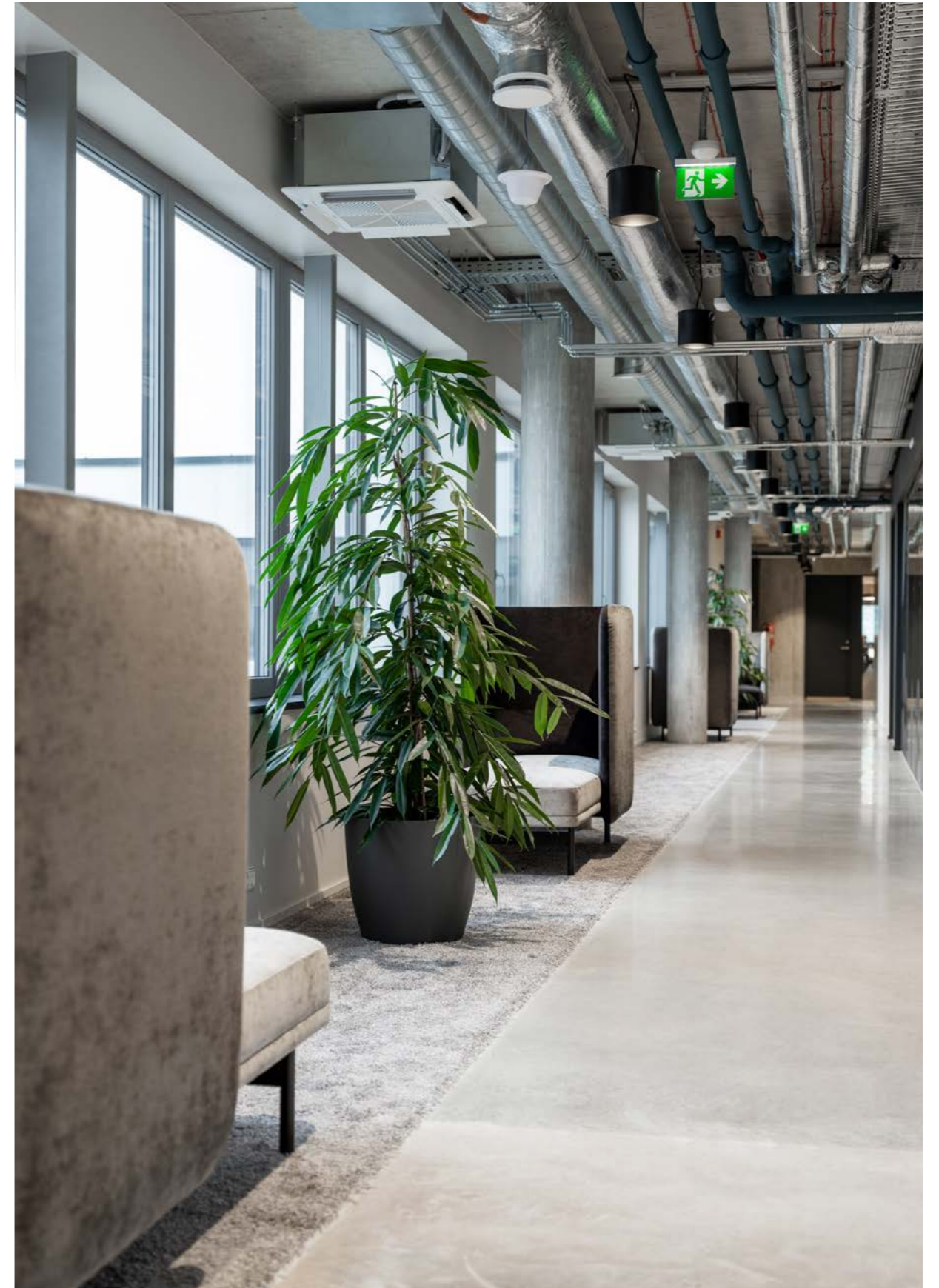

Net group office in Tallinn, Estonia. Photo: Tõnu Runnel

# Harles

## Soft office sofa

Design: Silver-Harles Haljandi

An office that feels like home creates a sense of warmth and belonging, where everyone feels welcomed and cared for. With its flowing form, Harles conveys this message in an effortless and chic way, with a touch of luxury.

The strength of the Harles sofa lies in its softness. Comfy seat cushions, filled with triple-layer foam, maintain their shape beautifully and make sitting a real pleasure. Designed with curves on all sides, Harles brings a sense of cosiness to any space, while its stylish high legs add an air of elegance. Opt for a seat module with a striking diagonal shape, and the character of Harles truly shines.



Welcome Zone



Social Zone



Collaboration Zone



Concentration Zone

Make waiting more comfortable

Feel homely and cosy

A nice place to chat

## PRODUCT INFORMATION

### Versions

Available in many different sizes

### Warranty

5 years

### Sustainability

Based on principles of the circular economy

### Certification



## STANDARD MATERIALS

### Frame

Solid wood and plywood, zigzag springs

### Seat and backrest

Durable HR foam; fire retardant HR foam on request

### Legs

Solid oak / Powder-coated metal

### Fabric upholstery

The cover fabric is removable

Choose any fabric from Intuit **Standard Fabric Collection**

### Additional information

As part of after-sales service we offer the change of cover fabric and all other components if needed



## LEGS



Solid oak legs, stained and varnished;  
anti-slip soles



Matt powder-coated metal legs;  
anti-slip soles

### **Solid oak**

Whitened



Natural



Wenge



Black



### **Powder-coated metal**

Jet Black RAL 9005



Other finishing options available on request.



## DIMENSIONS

Seat depth: 65 cm / Seat height: 59 cm

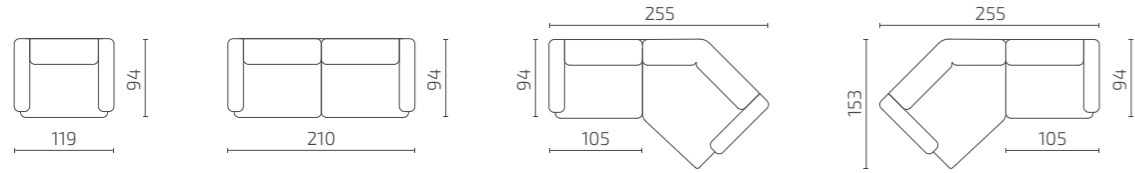

**S72-S15**

**S72-S3**

**S72-15CLCSR**

**S72-CSL15CR**

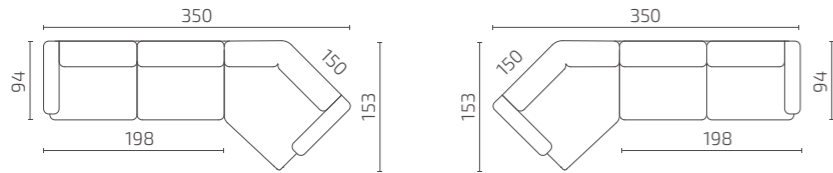

**S72-3CLCSR**

**S72-CSL3CR**

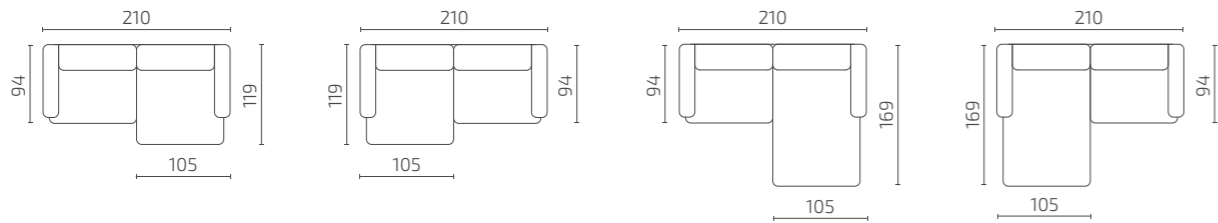

**S72-15CL1DSR**

**S72-1DSL15CR**

**S72-15CL1DMR**

**S72-1DML15CR**

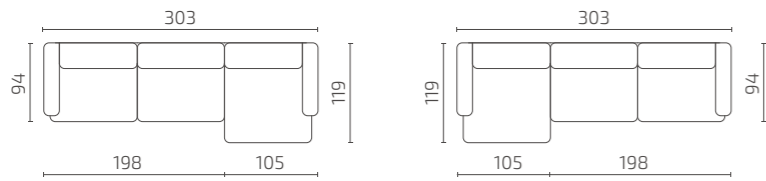

**S72-3CL1DSR**

**S72-1DSL3CR**

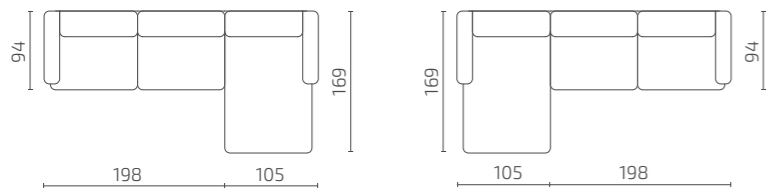

**S72-3CL1DMR**

**S72-1DML3CR**



Loveseat 1.5-Seat



3-Seat



3-Seat with corner module (right)



1.5-Seat with corner module (right)



1.5-Seat with small chaise longue (right)



1.5-Seat with extended chaise longue (right)



3-Seat with small chaise longue (right)



3-Seat with extended chaise longue (right)

All dimensions provided in centimetres.

# Hide

## Mobile office armchair

Design: Pent Talvet, Iseasi

A cozy nest in the middle of the office. Some tasks demand a different level of immersion. Some require that you get up from your desk, grab your laptop and slip into a more comfortable corner to allow your thoughts room to roam. The Hide has been specifically designed to be a soft nest to which office nomads can retreat.

Hide's mobility allows for easy repositioning to suit your needs, whether that means facing an inspiring view from a window or turning away from the noisy office crowd.



Concentration Zone

Create a homey atmosphere

Make for a perfect hideaway

## PRODUCT INFORMATION

### Versions

Available in 2 sizes

### Legs

360° rotating and lockable castors

### Warranty

5 years

### Sustainability

Based on principles of the circular economy

### Certification



## STANDARD MATERIALS

### Frame

Plywood and metal

### Seat & backrest

Durable HR foam; fire retardant HR foam on request

### Legs

Powder-coated metal

### Table and shelving

Veneered oak MDF board with solid wood edge

### Fabric upholstery

The cover fabric is not removable

Choose any fabric from **Intuit Standard Fabric Collection**

### Additional information

As part of after-sales service we offer the change of cover fabric and all other components if needed



## FINISHING OPTIONS

### Tabletop and shelving

#### Veneered MDF board

Natural oak



### Legs/Frame

#### Powder-coated metal

Jet Black RAL 9005



Other finishing options available on request.



360° rotating attached table



## DIMENSIONS

Seat height: 40 cm

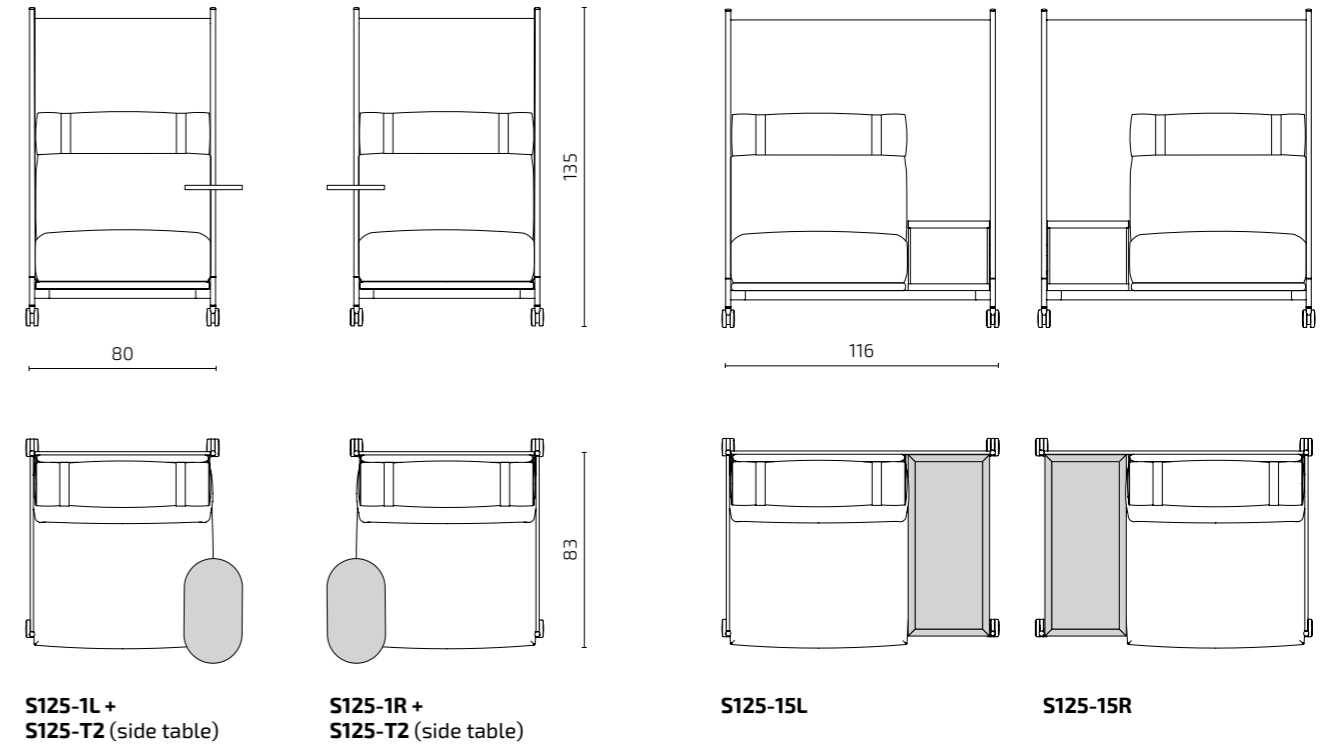

All dimensions provided in centimetres.

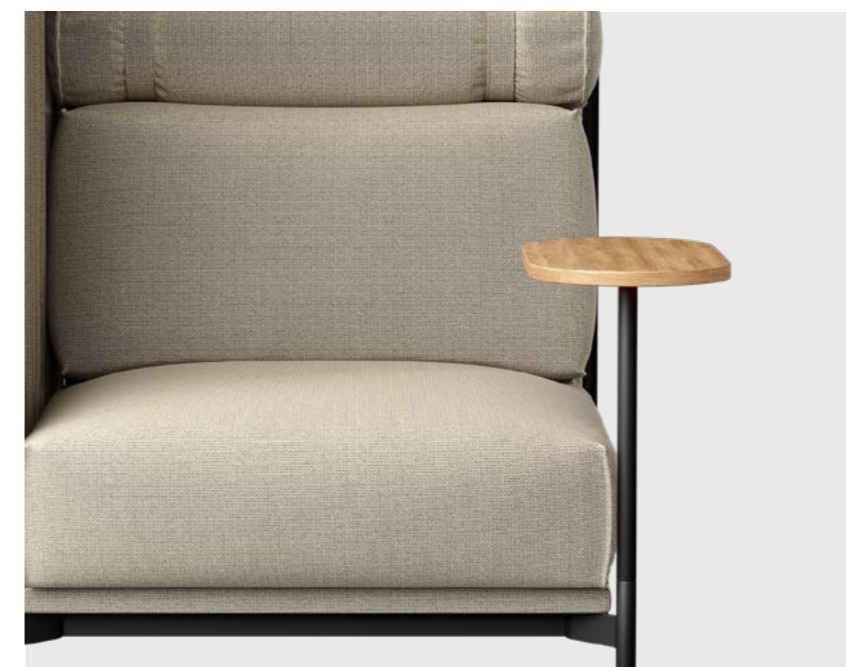

# Hubert & Hubert Mini

Available at  

## High and low chair for meeting tables

Design: Iseasi

A chair that lets you brainstorm in style. The sleek frame and raised seat of the Hubert help to support ergonomic posture effortlessly, while the 360° swivel base lets you rotate and rock while ideating – great for productive and dynamic team meetings.

Simple to maneuver, these chairs help you create a welcoming and agile collaboration space at a moment's notice.



Collaboration Zone

Bring heads together at a moment's notice

Encourage active problem-solving

Make your office flexible

## PRODUCT INFORMATION

### Versions

Available in bar stool and regular seat height

### Rocking base

Available with a rocking base and 360° rotating & tilting base

### Warranty

5 years

### Sustainability

Based on principles of the circular economy

### Certification



## STANDARD MATERIALS

### Frame

Plywood

### Seat & backrest

Durable HR foam; fire retardant HR foam on request

### Legs

Rocking base: oak

360° rotating & tilting base: plastic POM, black

### Fabric upholstery

The cover fabric is removable

Choose any fabric from **Intuit Standard Fabric Collection**

### Additional information

As part of after-sales service we offer the change of cover fabric and all other components if needed

SK ID Solutions office in Tallinn, Estonia. Photo: Märt Lillesiim





Ev. Hochschule in Freiburg, Germany



## DIMENSIONS

### Rocking base

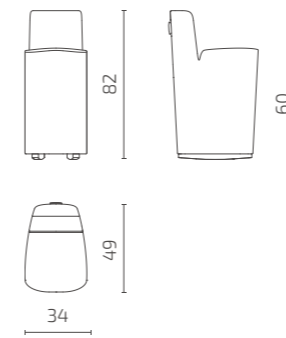

**S109-FL1**

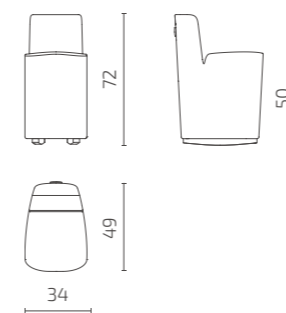

**S109-MFL1**

### 360° rotating & tilting base

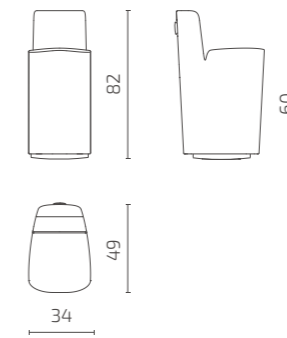

**S109-FL2**

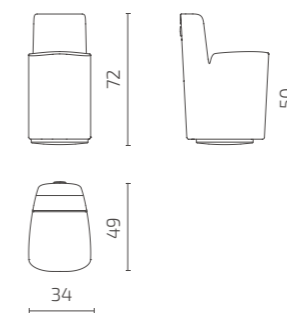

**S109-MFL2**

Seat depth: 36 cm

All dimensions provided in centimetres.

The chic design also comes in miniature. **Hubert Mini** has all the benefits of ergonomic design, manoeuvrability, and style, whilst being just the right size for regular meeting tables.





# Intro

## Lounge chair

Design: Argo Tamm

Not every office can cater for sprawling sofas and ping pong tables. But don't despair! If you're looking to create a flexible area for building community and encouraging relaxation, then we have what you need.

Compact, minimalist, oh so comfortable, Intro is easy to sink into with a cup of steaming coffee. And with its streamlined proportions you have an elegant solution to your space constraints.



Welcome Zone



Social Zone

Make your visitors feel welcome

Take a welcome break from your desk

Make connections with colleagues

## PRODUCT INFORMATION

**Leg**  
360° swivel base: metal leg and wood base

**Warranty**  
5 years

**Sustainability**  
Based on principles of the circular economy

### Certification



## FINISHING OPTIONS

### Leg

#### Solid oak

Natural

Wenge

Black



## STANDARD MATERIALS

**Frame**  
Metal

**Leg**  
Powder-coated metal leg and wood base

**Seat & backrest**  
High resiliency moulded PU foam

### Fabric upholstery

The cover fabric is not removable  
Choose any fabric from **Intuit Standard Fabric Collection**

### Additional information

As part of after-sales service we offer the change of cover fabric and all other components if needed

#### Powder-coated metal

Jet Black RAL 9005

Stone Grey RAL 7030

Traffic White RAL 9016



Other finishing options available on request.

## DIMENSIONS

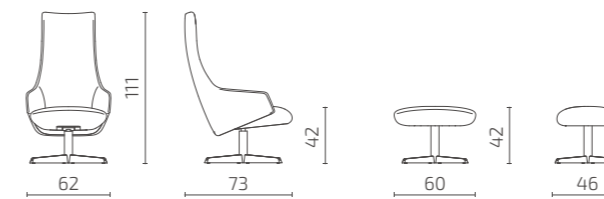

S64-S1

S64-F1

All dimensions provided in centimetres.



# Lilja

## Work sofa

Design: Samuli Naamanka

Transforming public spaces with Nordic elegance. Created in collaboration with Finnish designer Samuli Naamanka, Lilja is a tribute to the harmony and timelessness of Nordic design. Warm and friendly solid wood and elegant lines make up a pleasing piece of furniture that reflects the Nordic attitude to style and quality.

Lilja has flexibility at her heart, allowing you to tailor its setup to suit various spaces and personal tastes. Cherry-pick the armrest combinations. Optional backseat and armrest pillows enhance the comfort, inviting you to sink in and experience its welcoming embrace. Whether it's your office or any public area, Lilja promises to transform ordinary spaces into cozy, inviting environments. Much you value their comfort and wellbeing. Put the finishing touches to your Social Zone with this inviting sofa.



## PRODUCT INFORMATION

### Versions

Many different modules with and without armrests

### Modularity

Modules can be connected together

### Accessories

Additional backseat and armrest pillows

### Warranty

5 years

### Sustainability

Based on principles of the circular economy

### Certification



## STANDARD MATERIALS

### Frame

Solid wood and plywood

### Seat and backrest

Durable HR foam; fire retardant HR foam on request

### Leg frames

Solid oak / Powder-coated metal

### Pillows

Feather or fibre filling

### Fabric upholstery

The cover fabric is not removable

Choose any fabric from **Intuit Standard Fabric Collection**

### Additional information

As part of after-sales service we offer the change of cover fabric and all other components if needed

Tartu University Clinic, Estonia. Photo: Märt Lillesiim



Welcome Zone



Social Zone

Foster connections among colleagues

Welcome your visitors with a touch of home

Offer a restorative retreat from the daily grind

## FINISHING OPTIONS

### Leg frame

#### Solid oak

Natural



#### Powder-coated metal

Jet Black RAL 9005



Other finishing options available on request.



## SAMPLE COMBINATIONS

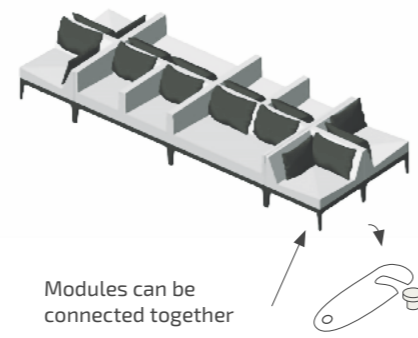
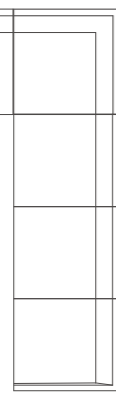
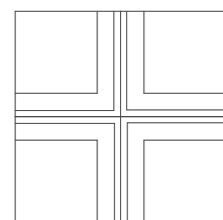
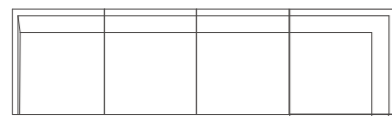
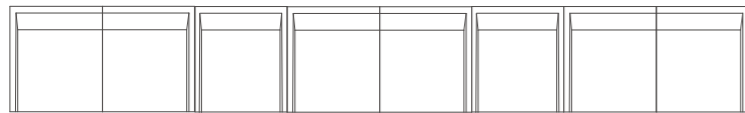
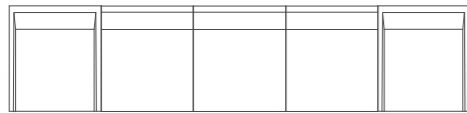
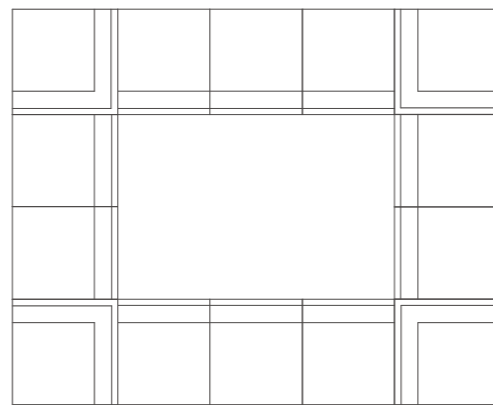
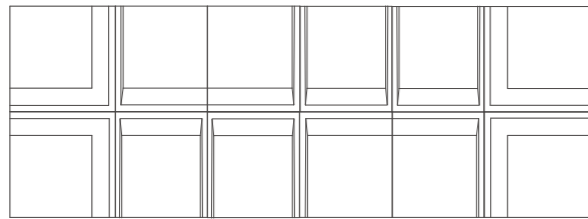

Modules can be connected together



Tartu University Clinic, Estonia. Photo: Märt Lillesiim

## DIMENSIONS

### Modules

Seat depth: 61 cm, with extra pillow 48 cm

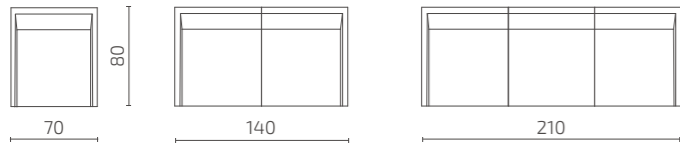
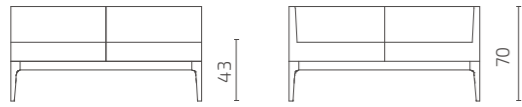

S102-S1

S102-1CL1CR

S102-1CL11CR

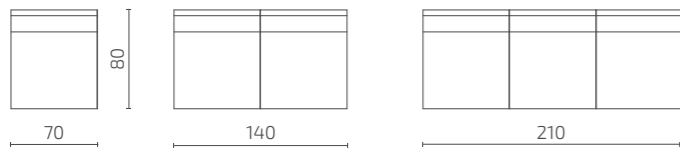

S102-1

S102-11

S102-111

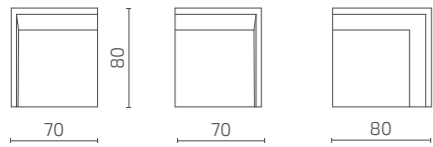

S102-1CL

S102-1CR

S102-C

### Oak leg frames

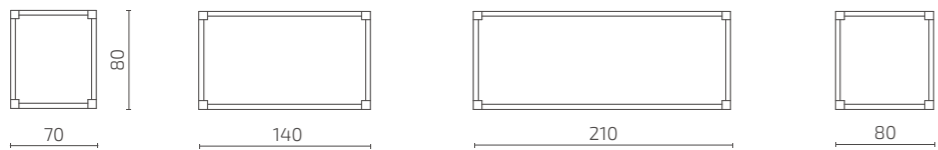

A0803-0039

A0803-0040

A0803-0041

A0803-0042

### Metal leg frames

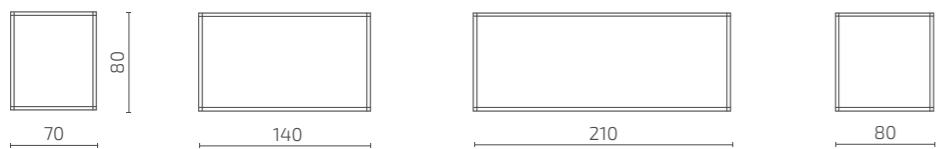

A0803-0050

A0803-0051

A0803-0052

A0803-0053

All dimensions provided in centimetres.

### Pillows



S102-P  
Back pillow



S102-KTP  
Armrest pillow



Tartu University Clinic, Estonia. Photo: Märt Lillesiim

# Loop, Duo & Twin

## Poufs

Design: Lauri Visnapuu

We think you should be able to gather wherever inspiration strikes. Which is why we've designed our trio of playful poufs to be the ultimate in flexible seating.

Grab them by their tabs and pull them over to your colleague's desk. So that you can carry on forming your new idea, without getting a crick in your neck.



Welcome Zone



Social Zone



Collaboration Zone

Bring some playful energy

Make your seating super flexible

Gather wherever you need to

## PRODUCT INFORMATION

### Versions

Available in 3 different shapes

### Warranty

5 years

### Sustainability

Based on principles of the circular economy

### Certification

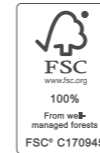

## STANDARD MATERIALS

### Frame

Solid wood and plywood

### Seat

Durable HR foam; fire retardant HR foam on request

### Fabric upholstery

The cover fabric is not removable

Choose any fabric from **Intuit Standard Fabric Collection**

### Additional information

As part of after-sales service we offer the change of cover fabric and all other components if needed

## DIMENSIONS

### Loop

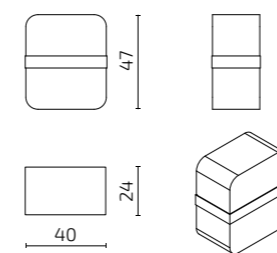

S116-F47

### Duo

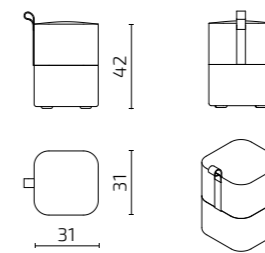

S117-F31

### Twin

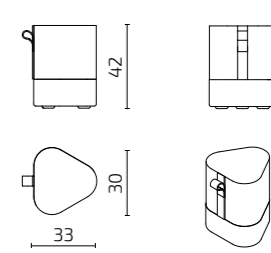

S118-F33

All dimensions provided in centimetres.



# Manhattan Hexa

Available at  
**pCon**  
 PLANNER

## Multifunctional hexagonal seating system

Design: Morten Nikolajsen

Elevate beyond the mundane with the Manhattan Hexa seating system, where traditional reception and social areas become hubs of engagement. The versatility of the unique hexagonal design allows for an array of configurations — from open, inviting layouts to more secluded seating areas ideal for educational institutions, airports, cinemas, and more.

With additional partition walls, the Manhattan Hexa can easily transform any public space into a tailored seating solution. Its design is particularly well-suited for learning environments, thanks to the playful shapes and the ability to employ various fabrics on the seating surface and sides.

## PRODUCT INFORMATION

### Versions

Available in 2 seating and 2 partition wall options

### Modularity

Modules can be connected together

### Legs

Adjustable legs

### Electrical outlet

Integrated electrical outlet

### Warranty

5 years

### Sustainability

Based on principles of the circular economy

### Certification



## STANDARD MATERIALS

### Frame

Solid wood and plywood

### Seat & backrest

Durable HR foam; fire retardant HR foam on request

### Legs

Plastic glide with felt sole

### Fabric upholstery

The cover fabric is not removable

Choose any fabric from **Intuit Standard Fabric Collection**

### Additional information

As part of after-sales service we offer the change of cover fabric and all other components if needed



Welcome Zone



Social Zone

Create a fun waiting spot

Make your visitors feel at home

Co-working space NUUUORK at Berlin Airport, Germany. Photo: Ariane Brille

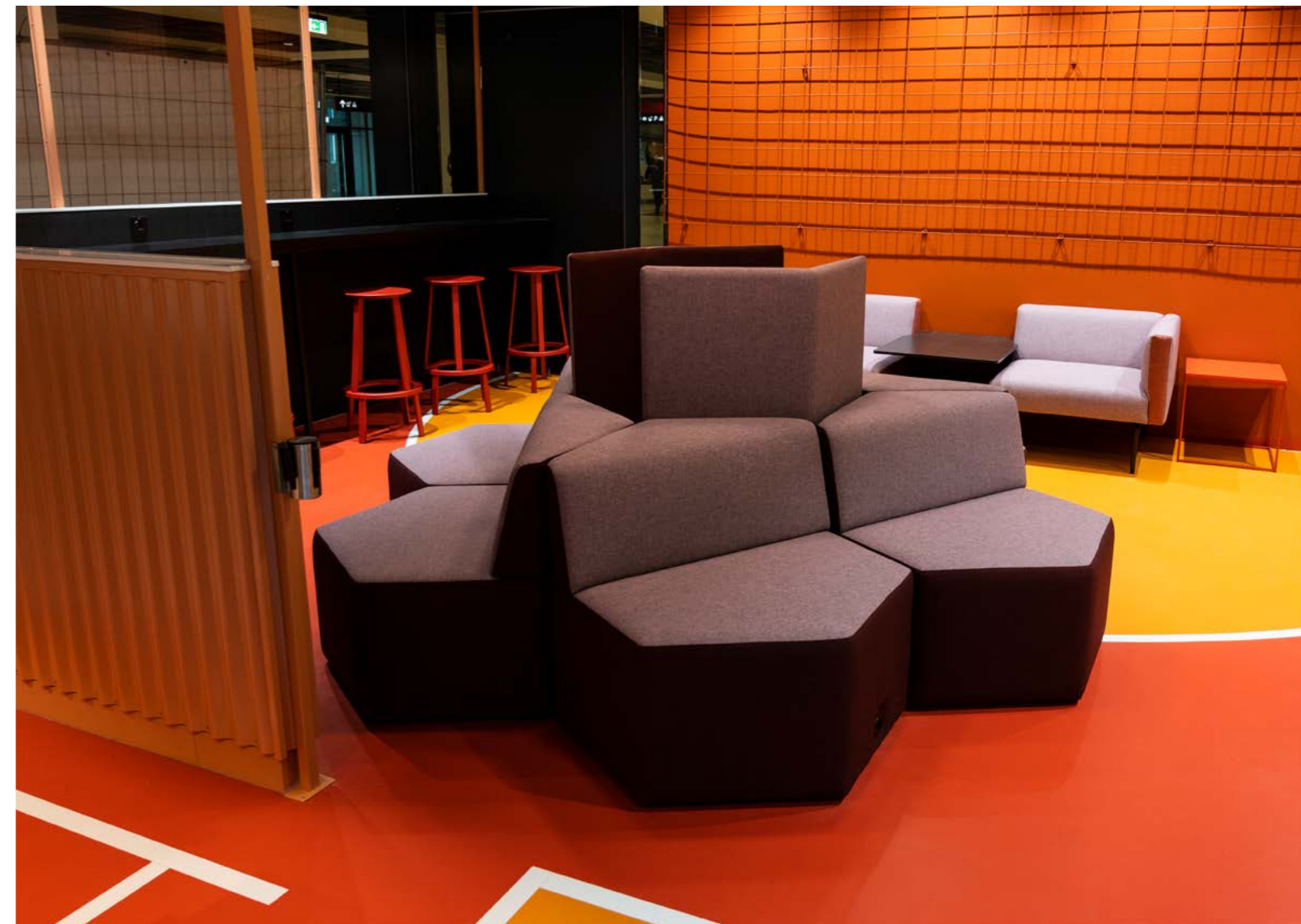

## ELECTRICAL OUTLET

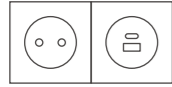

220V + USB A & C

Other electrical outlet combinations available on request.

**Berker Integro Flow**  
Color: Anthracite Matt

Available options DK, EU, FR, UK



## DIMENSIONS

Seat depth: 57 cm

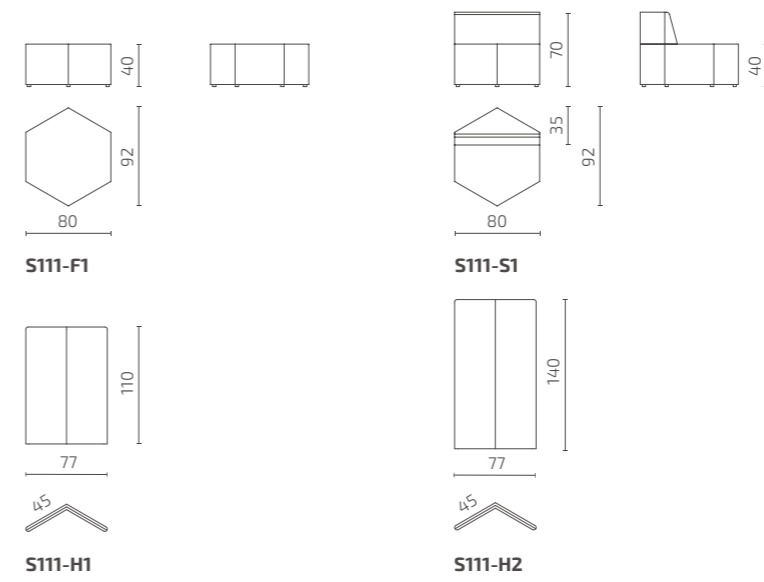

All dimensions provided in centimetres.

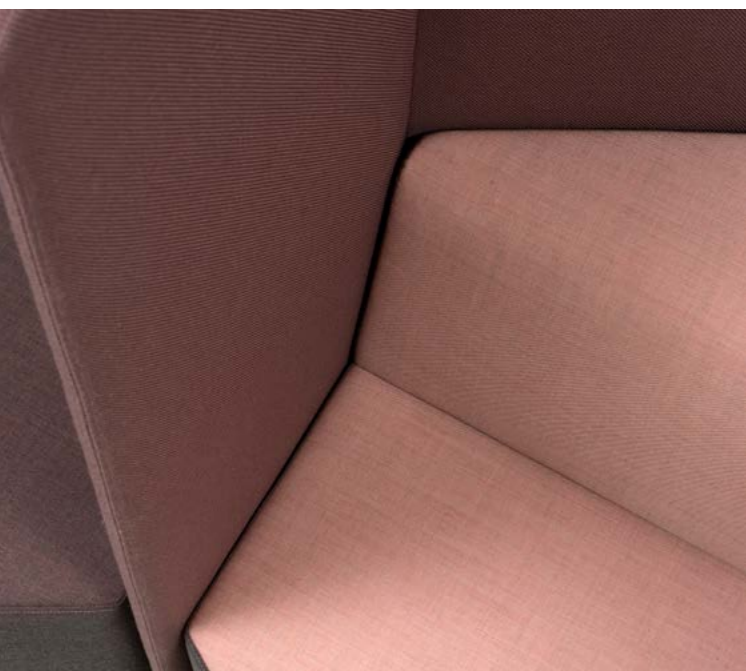

# Manhattan Penta

Available at  
**pCon**  
 PLANNER

## Multifunctional pentagonal seating system

Design: Morten Nikolajsen

Dive into the dynamic, fluid design with Manhattan Penta. Crafted for those who desire a playful yet functional space, this seating system doesn't just adapt — it transforms. Its unique pentagonal modules and varying heights allow for the creation of endless combinations, from intimate meeting spots to expansive seating arrangements. Add modular tables between seats and utilize the integrated plug-in options to enhance versatility and functionality.

Manhattan Penta's adaptability makes it ideal for a variety of public spaces. Whether setting the stage for collaboration in educational institutions, welcoming guests in office lobbies, or providing comfort in airport and cultural facility waiting areas, Penta ensures every space is both inviting and memorable. Give your guests more than just a place to sit — give them a topic of conversation and a reason to return.



Welcome Zone



Social Zone



Collaboration Zone

Create a fun waiting spot

Foster creative collaborations

Make your guests feel at home

## PRODUCT INFORMATION

### Versions

Available in 4 different heights and 2 different sizes

### Modularity

Modules can be connected together

### Accessories

Additional tables to add functionality to the seating area

### Electrical outlet

Integrated electrical outlet

### Warranty

5 years

### Sustainability

Based on principles of the circular economy

### Test & Certification

L1 European Standard strength, durability and safety certificate



## STANDARD MATERIALS

### Frame

Solid wood and plywood

### Seat & backrest

Durable HR foam; fire retardant HR foam on request

### Legs

Plastic glide with felt sole

### Table

High-pressure laminate with plywood edge band

### Fabric upholstery

The cover fabric is not removable

Choose any fabric from **Intuit Standard Fabric Collection**

### Additional information

As part of after-sales service we offer the change of cover fabric and all other components if needed

Lounge area at Tallinn Airport, Estonia. Photo: Märt Lillesiim





## FINISHING OPTIONS

### Tabletop

*High-pressure laminate, plywood edge*

Black



Other finishing options available on request.

## ELECTRICAL OUTLET

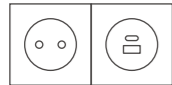

**220V + USB A & C**

**Berker Integro Flow**  
Color: Anthracite Matt

*Available options DK, EU, FR, UK*

Other electrical outlet combinations available on request.



Lounge area at Aalborg University, Denmark

## DIMENSIONS

### Modules

Seat depth: 50 cm  
(module S112-1ST: 44 cm)

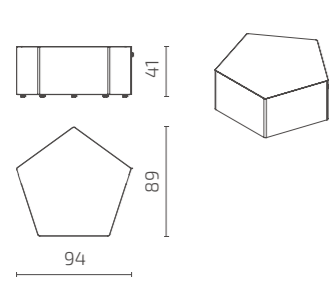

S112-F1

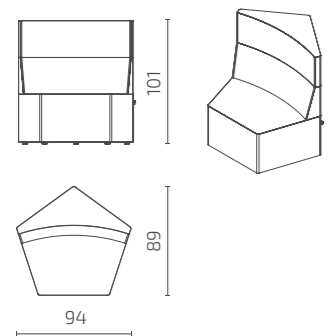

S112-1H2

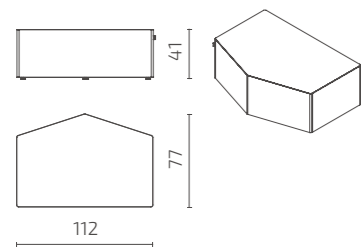

S112-FST

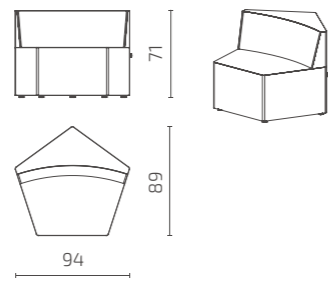

S112-1H1

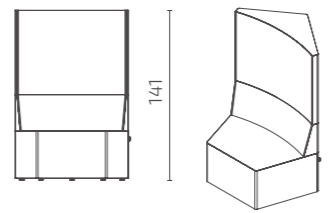

S112-1H3

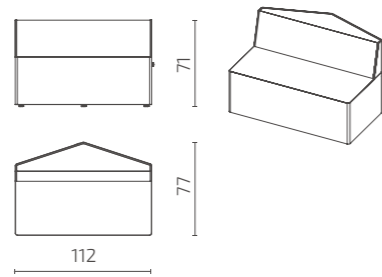

S112-1ST

### Tables

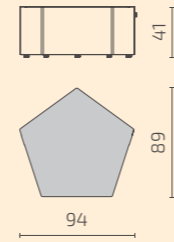

S112-T2  
Regular

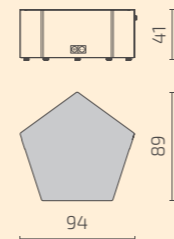

S112-T2E  
With electrical  
outlet option

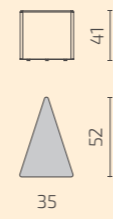

S112-T1  
Regular



S112-T1E  
With electrical  
outlet option

## SAMPLE COMBINATIONS

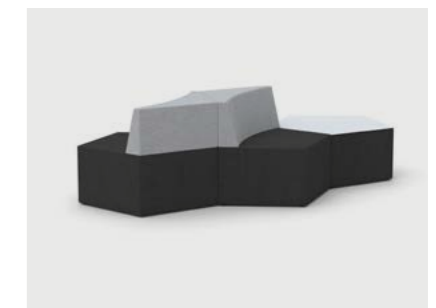
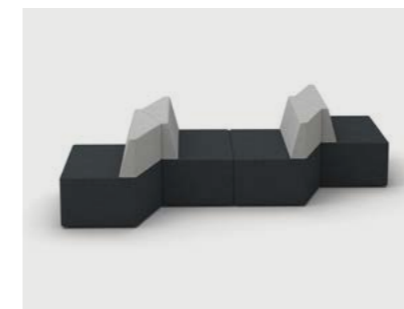
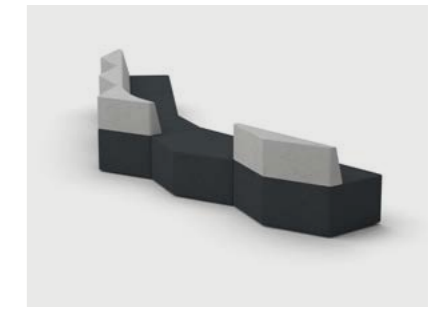

All dimensions provided in centimetres.

# Meeter Modular

Available at  
**pCon**  
 PLANNER

## Sofa modules

Design: Argo Tamm

Don't let your chairs distract from your chat. You can use the effortless design of the Meeter sofa modules wherever you want to bring people together. Perfect for those office reception areas and work cafes, Meeter has also found a happy home in the dining halls of catering establishments.

Renowned for its exceptional adaptability in both height and length, the Meeter sofa seamlessly integrates into any milieu. These compact sofas are engineered for endurance, effortlessly withstanding heavy usage and frequent cleaning.



## PRODUCT INFORMATION

### Versions

Available in 3 different heights and in 5 standard lengths

### Modularity

Modules can be connected together

### Legs

Available with regular legs and plinth

### Accessories

Attached side table to add functionality  
 Custom-made flower boxes to offer an organic touch of privacy

### Electrical outlet

Integrated electrical outlet

### Warranty

10 years

### Sustainability

Based on principles of the circular economy

### Test & Certification

- L2 European Standard strength, durability and safety certificate
- EU Ecolabel Certified



## STANDARD MATERIALS

### Frame

Solid wood and plywood

### Seat & backrest

Durable HR foam; fire retardant HR foam on request

### Legs

Solid oak / Powder-coated metal  
 Plinth: Veneer / Melamine / High-pressure laminate

### Table

Mass colored wood fibreboard / high-pressure laminate top with plywood edge; powder-coated metal frame

### Flower box

Veneer / Melamine / High-pressure laminate

### Fabric upholstery

The cover material is not removable  
 Choose any fabric from **Intuit Standard Fabric Collection**

### Additional information

As part of after-sales service we offer the change of cover fabric and all other components if needed

Hella Lithuania office in Kaunas, Lithuania. Photo: Norbert Tukaji



Welcome Zone



Social Zone

Create compact waiting spots

Make even your smaller dining areas comfy

Optimize space with flexible seating

## LEGS



Solid oak legs, stained and varnished; anti-slip soles







Powder-coated metal; anti-slip soles. Available in U-shape and straight legs



Plinth  
Additional cost will apply



### Solid oak

Whitened	
Natural	
Wenge	
Black	

### Powder-coated metal



Jet Black RAL 9005	
--------------------	---

### Plinth

Natural oak veneer	
Black melamine	
Matt black high-pressure laminate	

Other finishing options available on request.

## FLOWER BOX

Natural oak veneer	
Black melamine	
Matt black high-pressure laminate	

Other finishing options available on request.



## ELECTRICAL OUTLET

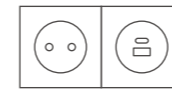

220V + USB A & C

Other electrical outlet combinations available on request.

**Berker Integro Flow**  
Color: Anthracite Matt

Available options DK, EU, FR, UK

## TABLE

### Tabletop

High-pressure laminate, plywood edge

Black	
-------	---

Mass-colored wood fibreboard

Grey	
Black	

### Table frame

Powder-coated metal

Jet Black RAL 9005	
--------------------	---

Other finishing options available on request.



Totaljobs office in Portsmouth, UK. Photo: Soren Kristensen



## DIMENSIONS

### Modules

Seat depth: 45 cm / Seat height: 46 cm  
 Standard lengths 62 / 80 / 100 / 120 / 150  
 Custom lengths available up to 200 cm

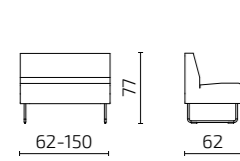

#### S108-1H162

S108-1H180  
 S108-1H1100  
 S108-1H1120  
 S108-1H1150

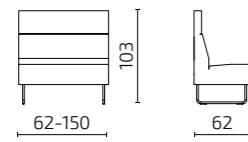

#### S108-1H262

S108-1H280  
 S108-1H2100  
 S108-1H2120  
 S108-1H2150

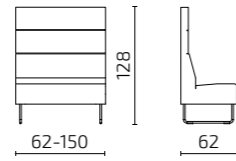

#### S108-1H362

S108-1H380  
 S108-1H3100  
 S108-1H3120  
 S108-1H3150

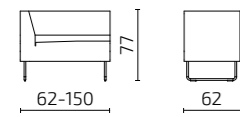

#### S108-1CLH162

S108-1CLH180  
 S108-1CLH1100  
 S108-1CLH1120  
 S108-1CLH1150

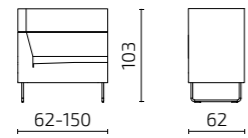

#### S108-1CLH262

S108-1CLH280  
 S108-1CLH2100  
 S108-1CLH2120  
 S108-1CLH2150

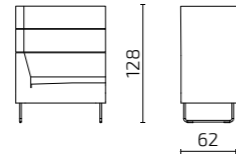

#### S108-1CLH362

S108-1CLH380  
 S108-1CLH3100  
 S108-1CLH3120  
 S108-1CLH3150

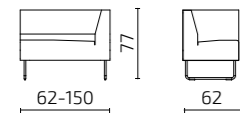

#### S108-1CRH162

S108-1CRH180  
 S108-1CRH1100  
 S108-1CRH1120  
 S108-1CRH1150

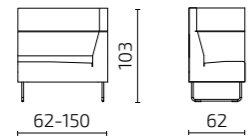

#### S108-1CRH262

S108-1CRH280  
 S108-1CRH2100  
 S108-1CRH2120  
 S108-1CRH2150

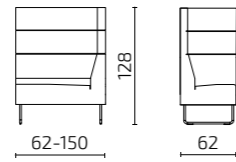

#### S108-1CRH362

S108-1CRH380  
 S108-1CRH3100  
 S108-1CRH3120  
 S108-1CRH3150

All dimensions provided in centimetres.

## SAMPLE MODULES

### Table

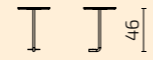

#### S108-T1

### Flower boxes

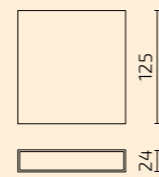
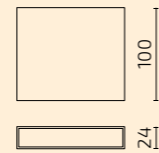
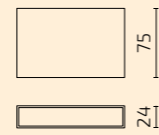

Length tailored to the full length of modular sofa



Length 100 cm / H1



Length 100 cm / H2



Length 100 cm / H3



Left corner / Length 100 cm / H1



Left corner / Length 100 cm / H2



Left corner / Length 100 cm / H3



Right corner / Length 100 cm / H1



Right corner / Length 100 cm / H2



Right corner / Length 100 cm / H3



Continental factory restaurant in Kaunas, Lithuania. Photo: Norbert Tukaji

**Shallow seating** makes the Meeter perfect for tighter places



Finnish Transport Infrastructure Agency in Helsinki, Finland. Photo: Hannakaisa Pekkala

# Meeter Round

Available at  

## Sofa modules

Design: Argo Tamm

Meeter Round, an evolution of the straight module, streamlines rows of seating. Its gently rounded silhouette and smooth curves optimise available space, creating an inviting seating area perfect for waiting rooms, cafés, and other public spaces.



Welcome Zone



Social Zone

Create compact waiting spots

Add elegance with a rounded silhouette

## PRODUCT INFORMATION

### Versions

Available in 3 different heights and 2 different shapes

### Modularity

Modules can be connected together

### Legs

Available with regular legs and plinth

### Accessories

Attached side table to add functionality

### Warranty

5 years

### Sustainability

Based on principles of the circular economy

### Certification



## STANDARD MATERIALS

### Frame

Solid wood and plywood

### Seat & backrest

Durable HR foam; fire retardant HR foam on request

### Legs

Solid oak / Powder-coated metal  
 Plinth: Veneer / High-pressure laminate

### Table

Mass colored wood fibreboard / high-pressure laminate top with plywood edge; powder-coated metal frame

### Fabric upholstery

The cover material is not removable  
 Choose any fabric from **Intuit Standard Fabric Collection**

### Additional information

As part of after-sales service we offer the change of cover fabric and all other components if needed



## LEGS



Solid oak legs, stained and varnished; anti-slip soles







Powder-coated metal; anti-slip soles. Available in U-shape and straight legs



Plinth  
Additional cost will apply



### Solid oak

Whitened	
Natural	
Wenge	
Black	

### Powder-coated metal

Jet Black RAL 9005	
--------------------	---

### Plinth

Natural oak veneer	
Matt black high-pressure laminate	

Other finishing options available on request.

## TABLE

### Tabletop

High-pressure laminate, plywood edge

Black	
-------	---

Mass-colored wood fibreboard

Grey	
Black	

### Table frame

Powder-coated metal

Jet Black RAL 9005	
--------------------	---



Other finishing options available on request.

## DIMENSIONS

Seat depth: 45 cm / height: 46 cm

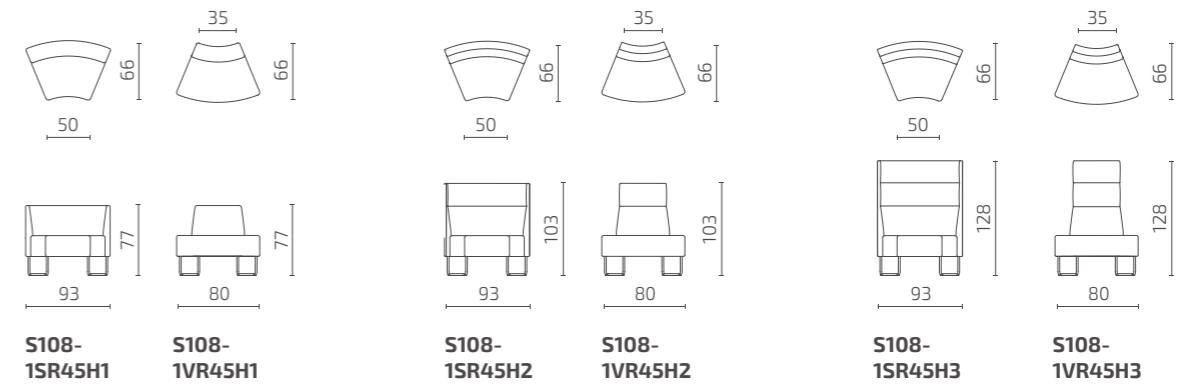

All dimensions provided in centimetres.

## SAMPLE COMBINATIONS

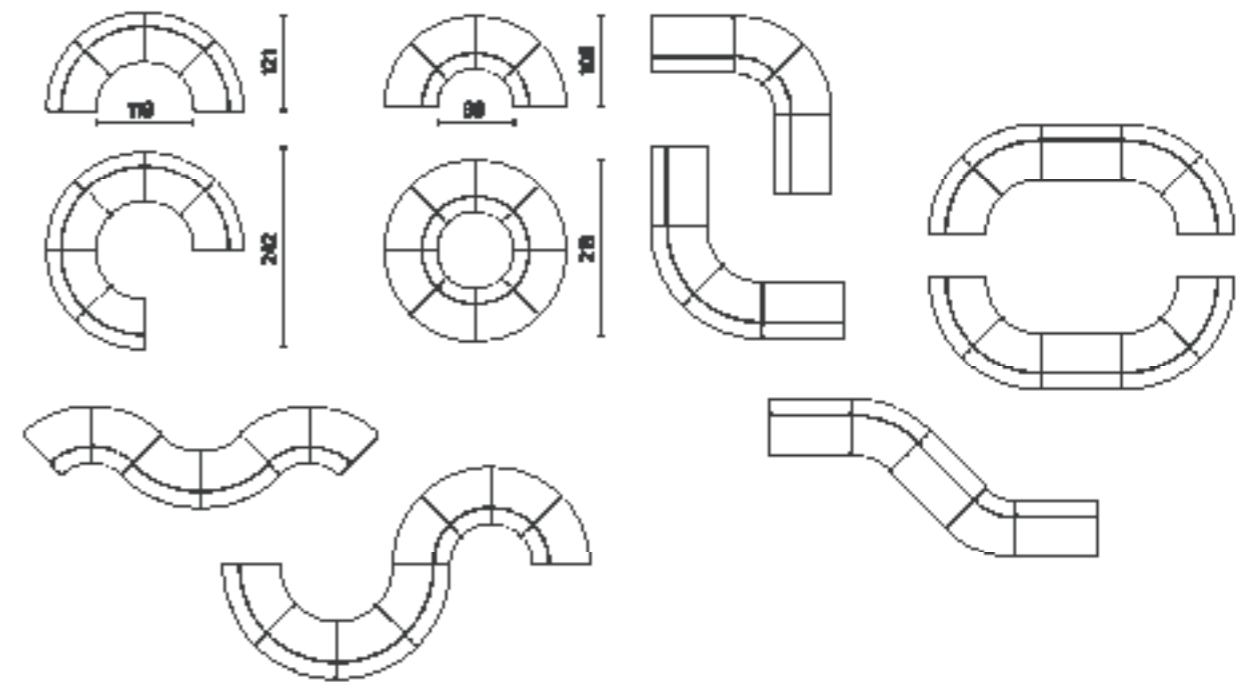

Round module with inner radius / H3

Round module with outer radius / H3



# Meeter Sofa & Armchair

Available at  

## Sofa and armchair

Design: Argo Tamm

The modern, simple lines of the Armchair & Sofa come in standard dimensions. Available in three widths, the modules seat one, two, or three people side by side. Choose from three backrest heights – the higher, the more private.



## PRODUCT INFORMATION

### Versions

Available in 3 different heights and 3 different sizes

### Legs

Available with regular legs and plinth

### Accessories

Attached side table to add functionality  
 Custom-made flower boxes to offer an organic touch of privacy

### Electrical outlet

Integrated electrical outlet

### Warranty

10 years

### Sustainability

Based on principles of the circular economy

### Test & Certification

- L2 European Standard strength, durability and safety certificate
- EU Ecolabel Certified



## STANDARD MATERIALS

### Frame

Solid wood and plywood

### Seat & backrest

Durable HR foam; fire retardant HR foam on request

### Legs

Solid oak / Powder-coated metal  
 Plinth: Veneer / Melamine / High-pressure laminate

### Tables

Mass colored wood fibre board / high-pressure laminate top with plywood edge; powder-coated metal frame

### Flower box

Veneer / Melamine / High-pressure laminate

### Fabric upholstery

The cover material is not removable  
 Choose any fabric from **Intuit Standard Fabric Collection**

### Additional information

As part of after-sales service we offer the change of cover fabric and all other components if needed



Welcome Zone



Social Zone

Create compact waiting spots

Elevate privacy with stylish high walls

## LEGS



Solid oak legs, stained and varnished; anti-slip soles



Powder-coated metal; anti-slip soles. Available in U-shape and straight legs



Plinth  
Additional cost will apply

### Solid oak

Whitened	
Natural	
Wenge	
Black	

Other finishing options available on request.

### Powder-coated metal

Jet Black RAL 9005	
--------------------	--

### Plinth

Natural oak veneer	
Black melamine	
Matt black high-pressure laminate	

## TABLE

### Tabletop

High-pressure laminate, plywood edge

Black	
-------	--

Mass-colored wood fibreboard

Grey	
Black	

### Table frame

Powder-coated metal

Jet Black RAL 9005	
--------------------	--

Other finishing options available on request.



## FLOWER BOX

Natural oak veneer	
Black melamine	
Matt black high-pressure laminate	

Other finishing options available on request.



## ELECTRICAL OUTLET

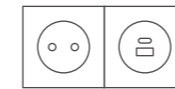

220V + USB A & C

Other electrical outlet combinations available on request.

**Berker Integro Flow**  
Color: Anthracite Matt

Available options DK, EU, FR, UK



## DIMENSIONS

### Armchair and sofa

Seat depth: 45 cm / Seat height: 46 cm

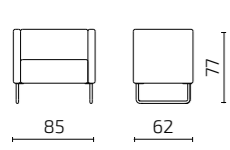

S108-S1H1

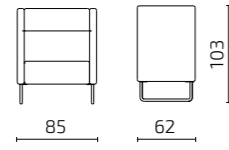

S108-S1H2

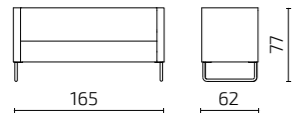

S108-S2H1

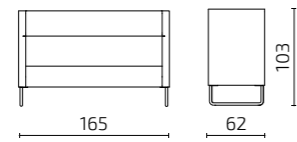

S108-S2H2

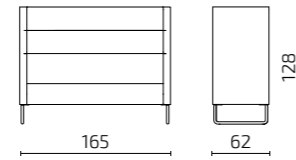

S108-S2H3

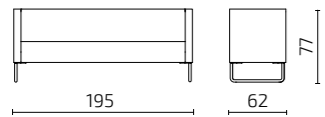

S108-S3H1

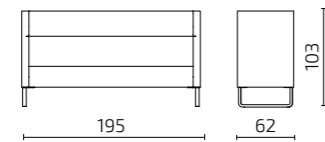

S108-S3H2

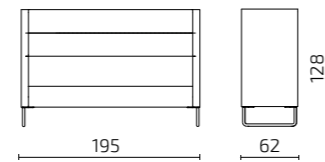

S108-S3H3

All dimensions provided in centimetres.

### Table

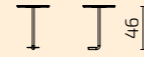

S108-T1

### Flower boxes

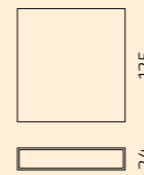
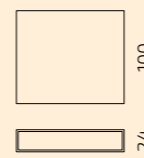
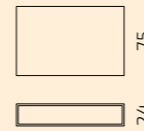

Length tailored to Meeter sofa



Armchair / H1



Armchair / H2



Sofa 2-Seat / H1



Sofa 2-Seat / H2



Sofa 2-Seat / H3



# Meeter Workbay

Available at  
**pCon**  
PLANNER

## Workstation

Design: Argo Tamm

The calm walls of the Meeter Workbay can contain the most important of conversations, or welcome the individual in for some deep focused work. We've all found the need for quiet and calm in the middle of a busy workplace. That's why we're helping you create the perfect Concentration Zone.

Meeter Workbay's minimalist design makes it an easy addition to any open-plan office, letting you create the private spaces you need.



## PRODUCT INFORMATION

### Versions

Available in 2 different sizes

### Legs

Available with regular legs and plinth

### Accessories

Additional tables to add functionality to the seating area

### Electrical outlet

Integrated electrical outlet

### Warranty

5 years

### Sustainability

Embraces the principles of circular design

### Test & Certification

- L1 European Standard strength, durability and safety certificate
- EU Ecolabel Certified



## STANDARD MATERIALS

### Frame

Solid wood and plywood

### Seat & backrest

Durable HR foam; fire retardant HR foam on request

### Wall fastenings

Powder-coated metal

### Legs

Solid oak / Powder-coated metal  
Plinth: Veneer / Melamine / High-pressure laminate

### Tables

Matt high-pressure laminate, or mass-colored wood fibreboard top with powder-coated metal legs

### Fabric upholstery

The cover material is not removable  
Choose any fabric from **Intuit Standard Fabric Collection**

### Additional information

As part of after-sales service we offer the change of cover fabric and all other components if needed

Finnish Transport Infrastructure Agency in Helsinki, Finland. Photo: Hannakaisa Pekkala



Collaboration Zone



Concentration Zone

Divide your space organically

Give the option of focus and seclusion

Cut down on background noise

Hold your own private meeting

## LEGS



Solid oak legs, stained and varnished; anti-slip soles







Powder-coated metal; anti-slip soles. Available in U-shape and straight legs



Plinth  
Additional cost will apply



### Solid oak

Whitened	
Natural	
Wenge	
Black	

### Powder-coated metal

Jet Black RAL 9005	
--------------------	---

### Plinth

Natural oak veneer	
Black melamine	
Matt black high-pressure laminate	

Other finishing options available on request.

Ev. Hochschule in Freiburg, Germany







## TABLES



Aide cafeteria / work tables





### Aide tabletop

#### High-pressure laminate

Alpine White Egger W1100 PM	
Soft Black Egger U899 PM	
Stone Green Egger U665 PM	
Garnet Red Egger U399 PM	

### Aide table legs

#### Powder-coated metal

Signal White RAL 9003	
Jet Black RAL 9005	
Tarpaulin Grey RAL 7010	
Black Red RAL 3007	

Other finishing options available on request.

## ELECTRICAL OUTLET

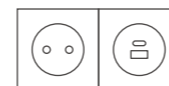

220V + USB A & C

Other electrical outlet combinations available on request.



August table with plywood edge

### August tabletop

#### High-pressure laminate, plywood edge

Black	
-------	---

#### Mass-colored wood fibreboard

Grey	
Black	

### August table legs

#### Powder-coated metal

Jet Black RAL 9005	
--------------------	---

**Berker Integro Flow**  
Color: Anthracite Matt

Available options DK, EU, FR, UK

## DIMENSIONS

### Workbay

Seat height: 46 cm

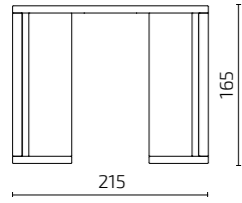
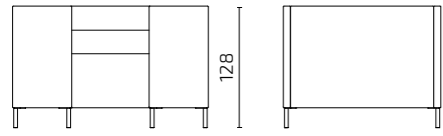

**S108-WS2H3**

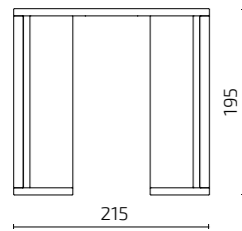
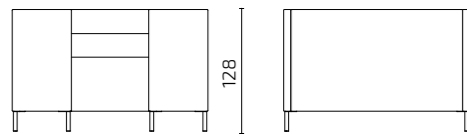

**S108-WS3H3**

All dimensions provided in centimetres.



## Tables

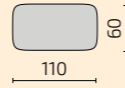
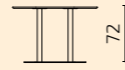

**S128-T1M**  
AIDE table

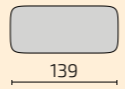
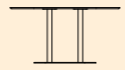

**S128-T3M**  
AIDE table

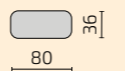
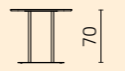

**S101-T1**  
AUGUST table

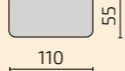
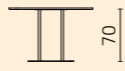

**S101-T3**  
AUGUST table



# Meeter Chair

## Dining chair

Design: Argo Tamm

Elevating the Meeter product line, the latest addition is the Meeter chair that boasts sleek, contemporary lines, perfectly complementing its sofa counterparts.



Welcome Zone



Social Zone



Collaboration Zone

## PRODUCT INFORMATION

**Warranty**  
5 years

**Sustainability**  
Based on principles of the circular economy

### Certification



## STANDARD MATERIALS

**Frame**  
Plywood

**Seat & backrest**  
Durable HR foam; fire retardant HR foam on request

**Legs**  
Powder-coated metal, anti-slip soles

**Armrest**  
Plywood with high-pressure laminate on top

**Fabric upholstery**  
The cover material is not removable  
Choose any fabric from **Intuit Standard Fabric Collection**

**Additional information**  
As part of after-sales service we offer the change of cover fabric and all other components if needed

## FINISHING OPTIONS

### Legs

**Powder-coated metal**

Jet Black RAL 9005

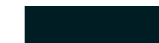

### Armrest

**High-pressure laminate**

Black



Other finishing options available on request.

## DIMENSIONS

Seat depth: 45 cm

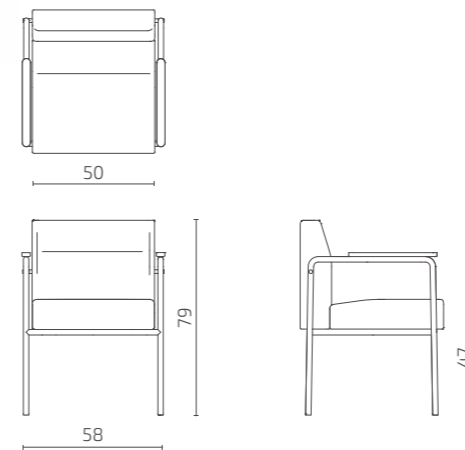

S108-ST1

All dimensions provided in centimetres.



# Sans

Available at  
**pCon**  
 PLANNER

## Soft work sofa

Design: Argo Tamm

The Sans versatile sofa family provides a welcoming resting place in the welcome and social areas. Comfortable and practical for a communal space, the Sans is available as a classic sofa, or with an integral table. And, when equipped with eye-level walls, it's the perfect home for intimate conversations in any breakout spaces. Pop down your coffee cup, lean back, and enjoy the clean lines and sociable layout.



## PRODUCT INFORMATION

### Versions

Many different sizes and combinations

### Accessories

Various additional tables  
 Additional pillows

### Electrical outlet

Under the seating mounted to the frame  
 Integrated in the table top

### Warranty

5 years

### Sustainability

Based on principles of the circular economy

### Test & Certification

L1 European Standard strength, durability and safety certificate



## STANDARD MATERIALS

### Frame

Solid wood and plywood

### Seat & backrest

Durable HR foam; fire retardant HR foam on request

### Legs

Powder-coated metal frame; plastic soles

### Tables

High-pressure laminate table top with plywood edge, powder-coated metal frame

### Pillows

Feather filling

### Fabric upholstery

The cover material is not removable

Choose any fabric from **Intuit Standard Fabric Collection**

### Additional information

As part of after-sales service we offer the change of cover fabric and all other components if needed

Co-working space NUUUORK at Berlin Airport, Germany. Photo: Ariane Brille



Welcome Zone



Social Zone



Collaboration Zone

Divide your space organically

Offer up moments of rest and relaxation

Make your visitors feel at home



## FINISHING OPTIONS

### Leg frame

#### Powder-coated metal

Jet Black RAL 9005



### Tabletop

#### High-pressure laminate, plywood edge

Black



### Table frame

#### Powder-coated metal

Jet Black RAL 9005



Other finishing options available on request.



## ELECTRICAL OUTLET

### Under the seating attached to the frame

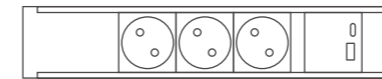

3x 220V + USB A & C

### Integrated in the table top



220V + USB A

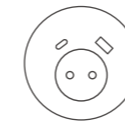

220V + USB A & C

Other electrical outlet combinations available on request.

### Bachmann Power Strip

Color: Black Matt

Available options DK, EU, FR, UK

### Powerdot Compact 61

Color: Black Matt

Available options EU, FR, UK

### Powerdot 16

Color: Black Matt

Available options DK, EU, FR

Savant Zorg office in the Netherlands



SAMPLE COMBINATIONS

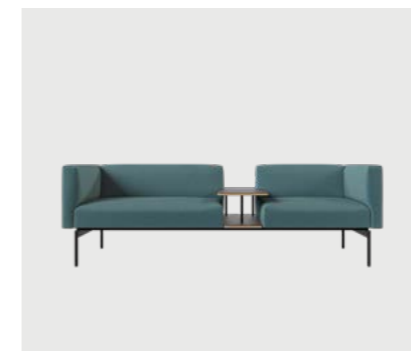
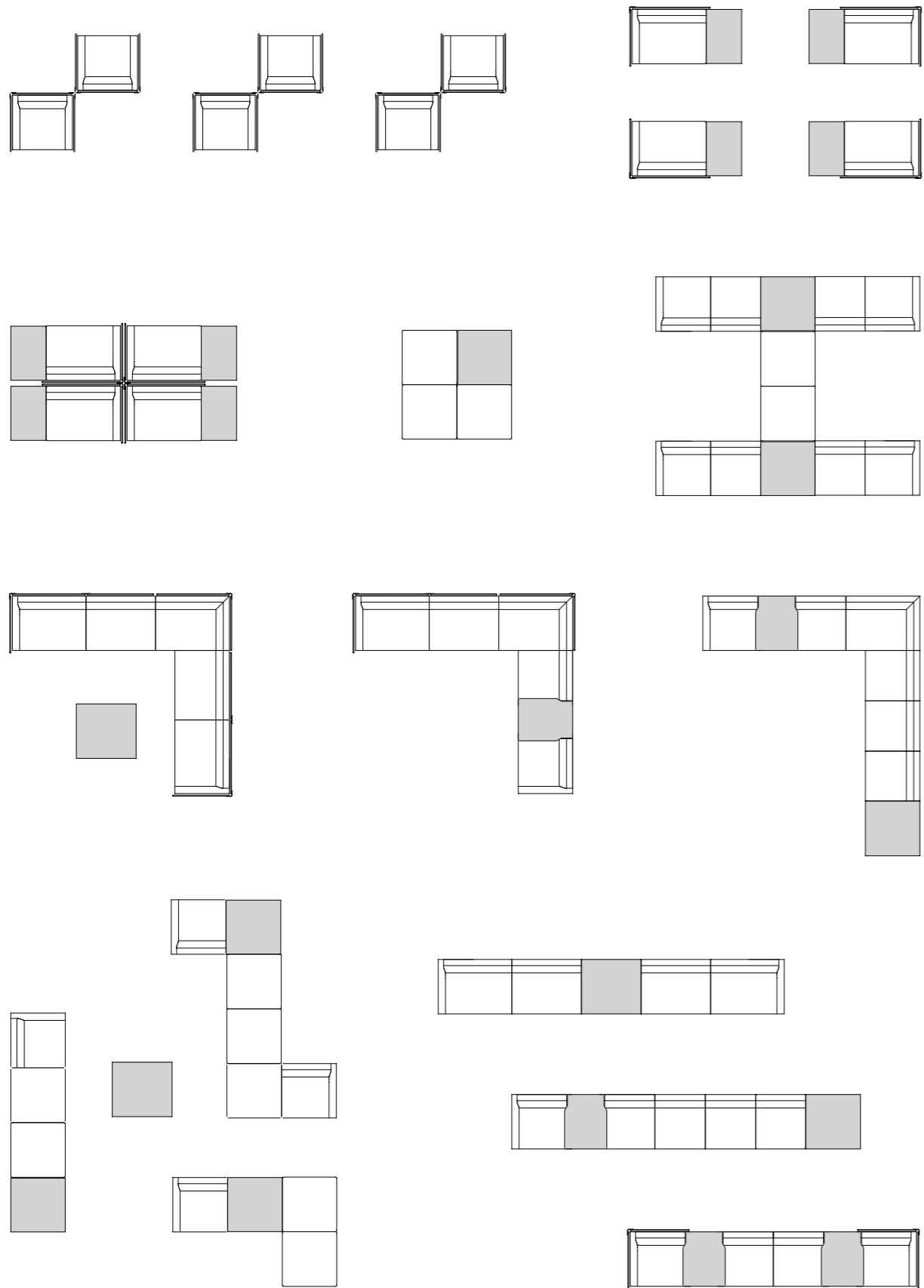

## DIMENSIONS

### Individual modules

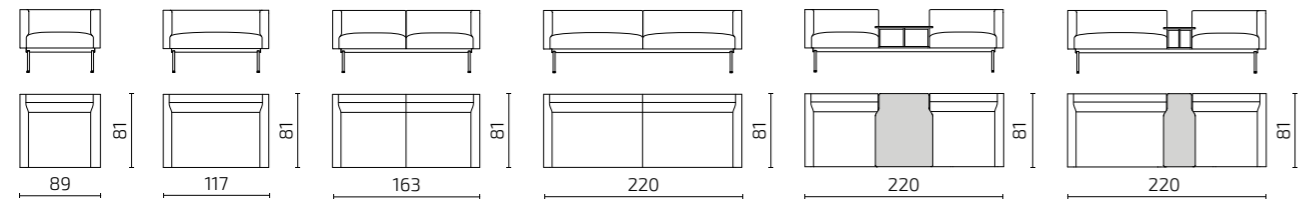
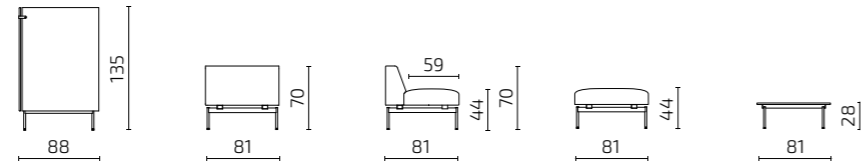

**S113-S1 S113-S15 S113-S2 S113-S3 S113-1CLT41CR S113-15CLT51CR**

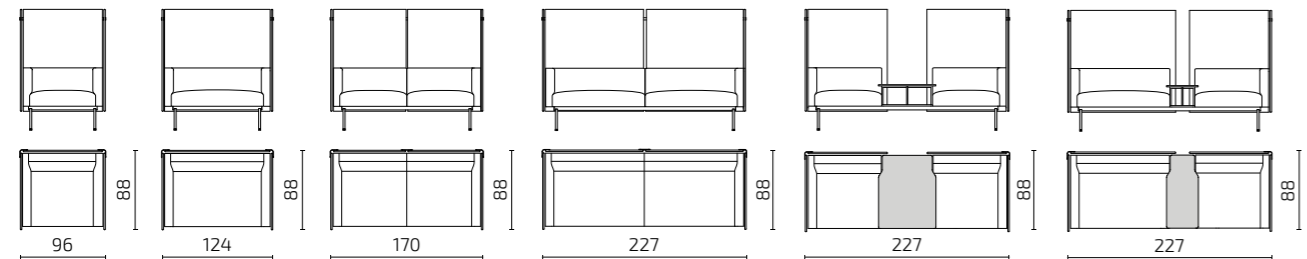

**S113-SW1 S113-SW15 S113-SW2 S113-SW3 S113-1CLWT41CRW S113-15CLWT51CRW**

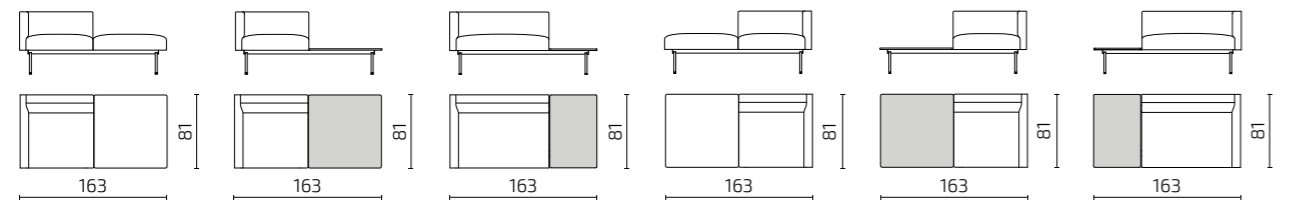

**S113-1CLF1 S113-1CLT2 S113-15CLT3 S113-F11CR S113-T21CR S113-T315CR**

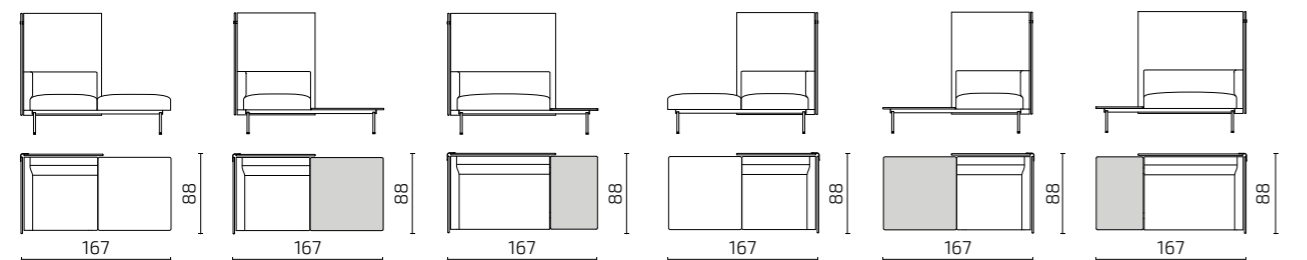

**S113-1CLWF1 S113-1CLWT2 S113-15CLWT3 S113-F11CRW S113-T21CRW S113-T315CRW**

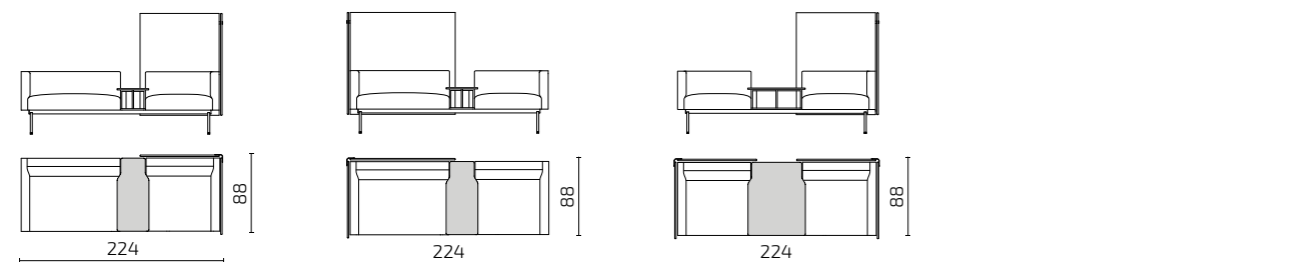

**S113-15CLT51CRW S113-15CLWT51CR S113-1CLT41CRW**

## DIMENSIONS

### Daybed

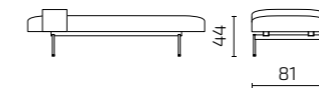

**S113-DB1**

### Poufs and tables

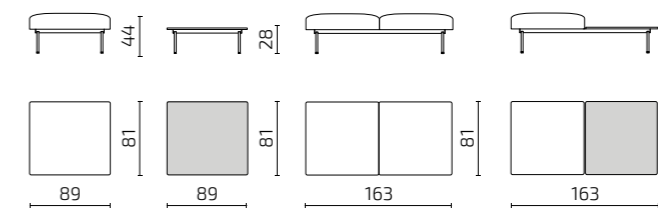

**S113-F S113-T1 S113-F2 S113-F1T2**

### Pillows

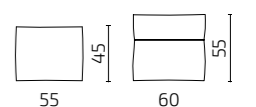

**S113-P1 S113-P2**

### Modules to combine

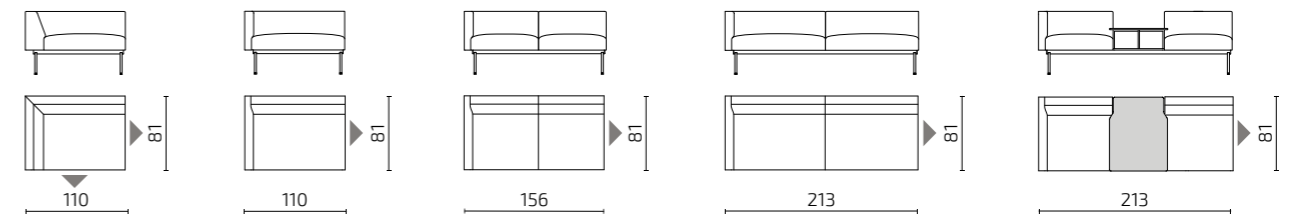

**S113-CL S113-15CL S113-2CL S113-3CL S113-1CLT41**

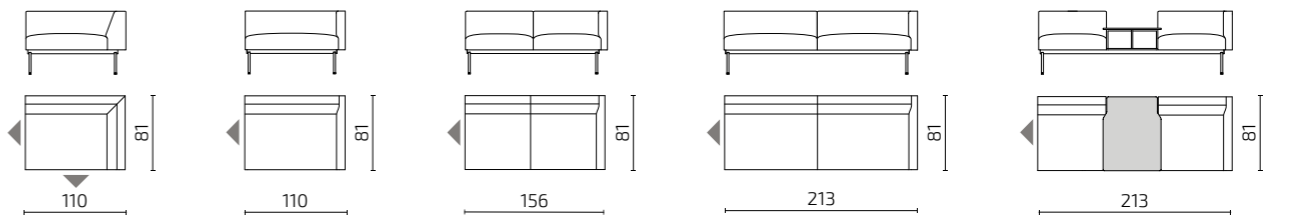

**S113-CR S113-15CR S113-2CR S113-3CR S113-1T41CR**

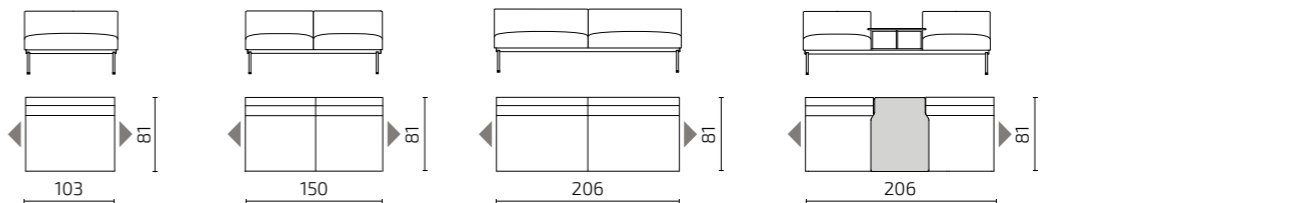

**S113-15 S113-2 S113-3 S113-1T41**

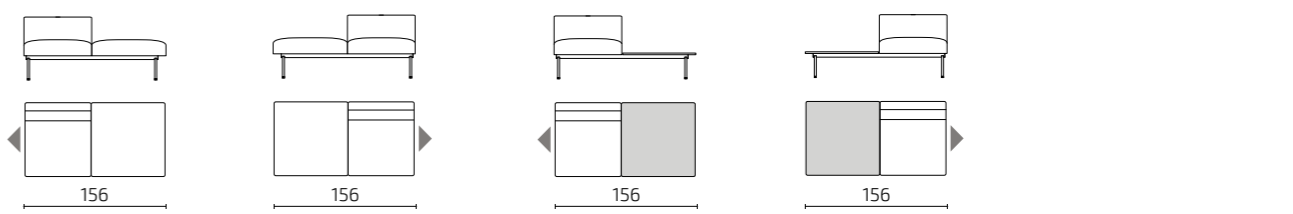

**S113-1F1 S113-F11 S113-1T2 S113-T21**

All dimensions provided in centimetres.

Modules to combine

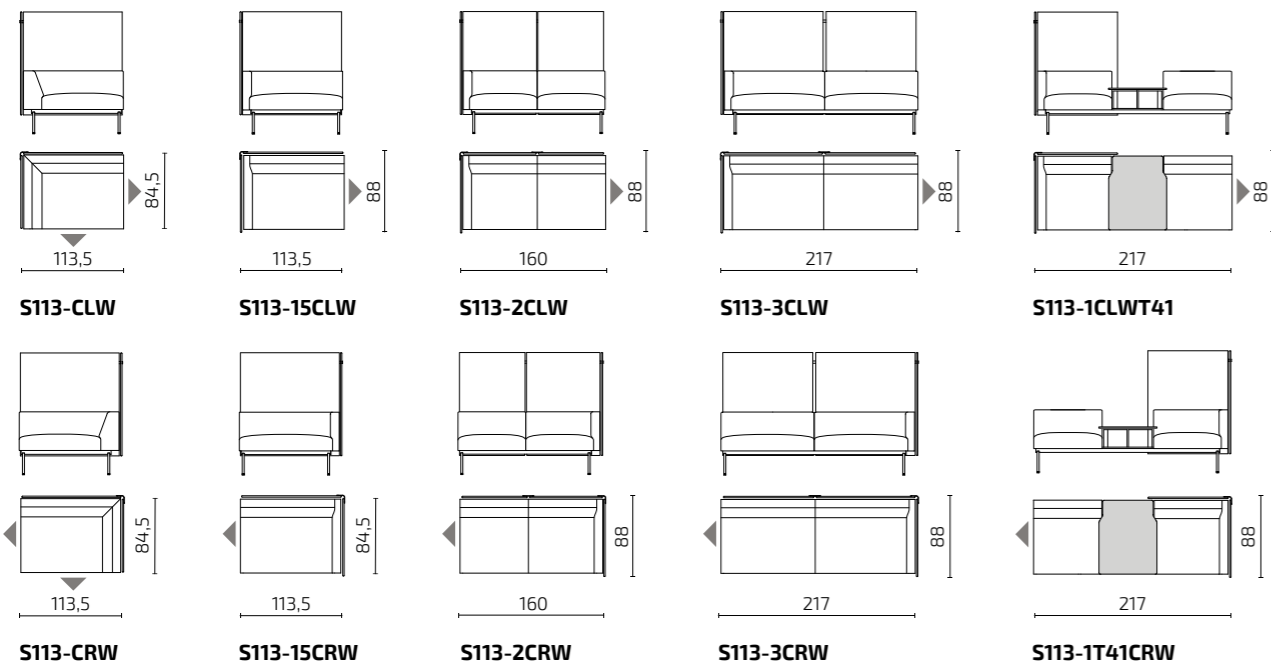

# Sofi

## Sofa & pouf system

Design: Janno Nõu, Iseasi

Kick back and relax. With their fresh look and slim proportions, the Sofi sofa and pouf make even the smallest Welcome Zones inviting. Your visitors will want to put their feet up and settle in with a coffee – so comfy they won't even mind if you're a little late!



Welcome Zone

Create cosy spots in even the smallest spaces

Move around as the conversation flows

Make your guests feel at home

## PRODUCT INFORMATION

### Versions

Available as a sofa, bench and 2 pouf shapes

### Warranty

5 years

### Sustainability

Based on principles of the circular economy

### Certification



## STANDARD MATERIALS

### Frame

Solid wood and plywood

### Seat & backrest

Durable HR foam; fire retardant HR foam on request

### Legs

Stained solid oak

### Fabric upholstery

The cover fabric is not removable

Choose any fabric from **Intuit Standard Fabric Collection**

### Additional information

As part of after-sales service we offer the change of cover fabric and all other components if needed

Kääriku Sports Center, Estonia. Photo: Tõnu Runnel



## LEGS

### Solid oak

Whitened

Natural

Wenge

Black

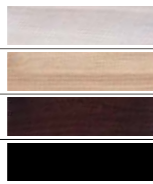

Other finishing options available on request.



## DIMENSIONS

Seat depth: 48 cm

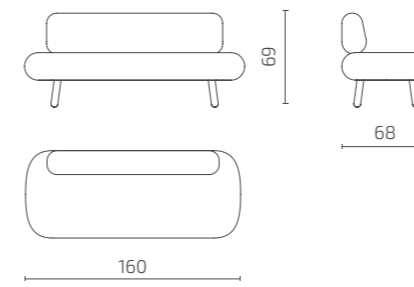

**S105-S2**

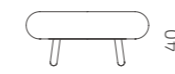

**S105-F90**

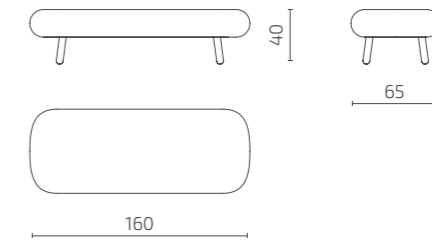

**S105-F2**



**S105-F1**

All dimensions provided in centimetres.



# Spot

## Multifunctional seating furniture

Design: Pent Talvet, Iseasi

Spot is a centre of attraction, one that dominates both the Welcome and Social zones. The four modules can be used to create varied solutions for one or more seated individuals. Whether Spot provides privacy for someone waiting or facilitates communication depends entirely on its placement.

Always practical, Spot is a combination of an inviting seating area and a useful supporting surface. The shelves surrounding the seat form ideal supports on which to place a computer or simply to lean against. The shelves feature integrated sockets, enabling Spot to serve as a workspace, if desired. In addition to books and houseplants, the shelves confidently support various furnishing elements that enliven the space. Spot also makes it easy to divide rooms into zones.



Welcome Zone



Social Zone



Collaboration Zone

Can serve several functions

A comfortable place to wait

Create an inviting atmosphere

## PRODUCT INFORMATION

### Versions

Available in 3 different sized modules

### Modularity

Modules can be connected together

### Electrical outlet

Integrated electrical outlet

### Warranty

5 years

### Sustainability

Based on principles of the circular economy

### Certification



## STANDARD MATERIALS

### Frame

Plywood

### Seat and backrest

Durable HR foam; fire retardant HR foam on request

### Legs

Powder-coated metal frame, anti-slip soles (optional)

### Shelving

Pine plywood or oak veneer; top board high-pressure laminate

### Table

High-pressure laminate

### Fabric upholstery

The cover fabric is not removable

Choose any fabric from **Intuit Standard Fabric Collection**

### Additional information

As part of after-sales service we offer the change of cover fabric and all other components if needed

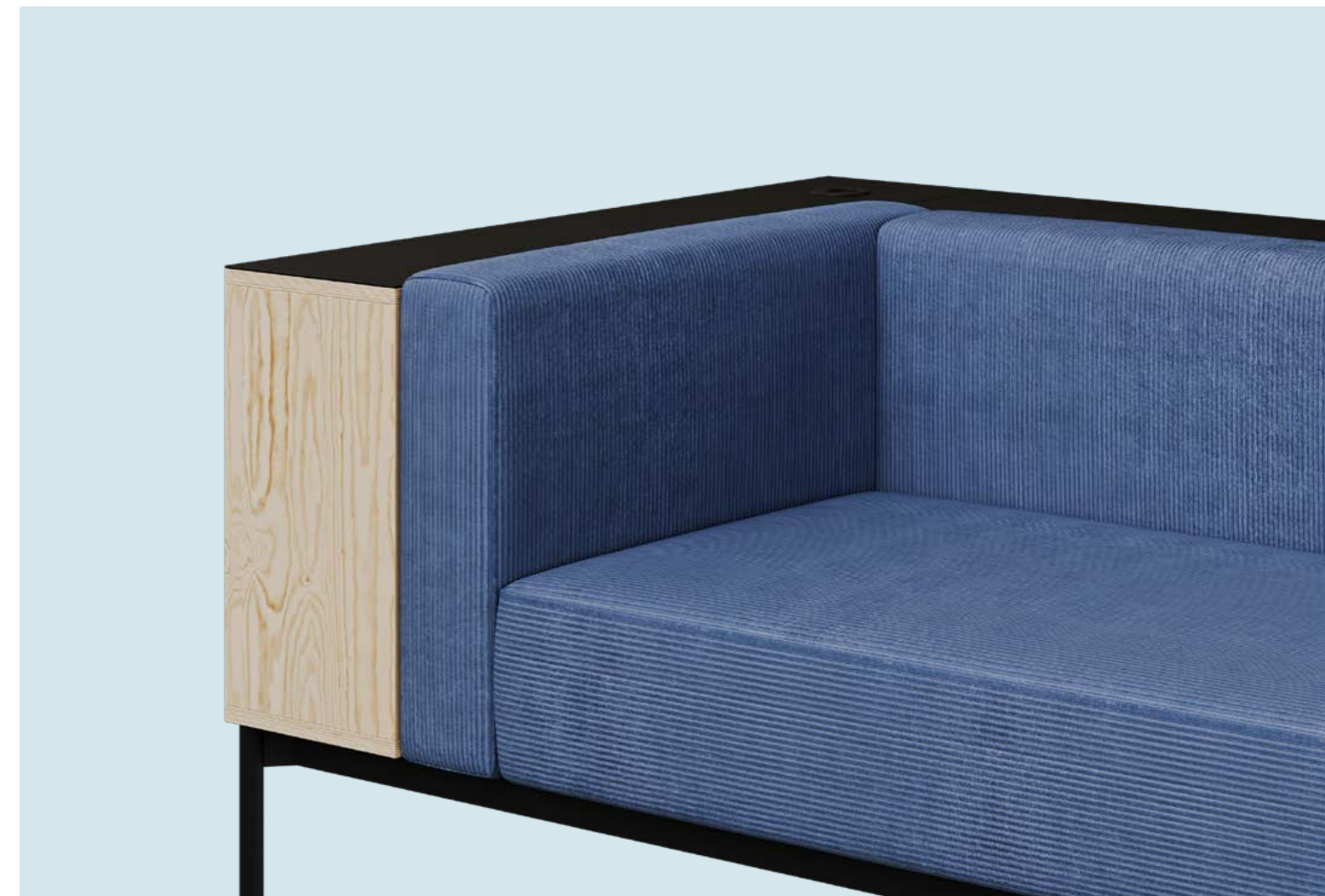

## FINISHING OPTIONS

### Leg frame

#### *Powder-coated metal*

Jet Black RAL 9005



### Tabletop / Top board

#### *High-pressure laminate*

Black



### Shelving

#### *Pine plywood*

Natural pine



#### *Oak veneer*

Natural oak



Other finishing options available on request.



## ELECTRICAL OUTLET



220V + USB A & C

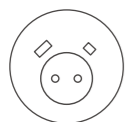

220V + USB A + data

Other electrical outlet combinations available on request.

### Powerdot 16

Color: Black Matt

Available options DK, EU, FR

### Powerdot 12

Color: Black Matt

Available options UK





## DIMENSIONS

Left corner module 1-Seat

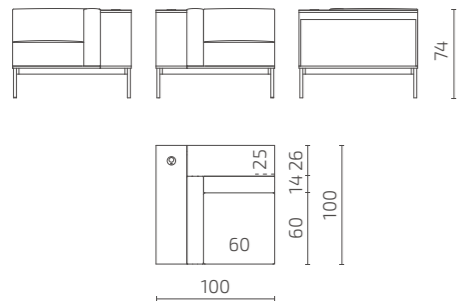

S126-1CLA

Right corner module 1-Seat

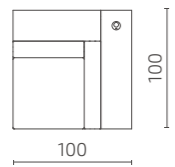

S126-1CRA

Left corner module 2-Seat with back shelf only

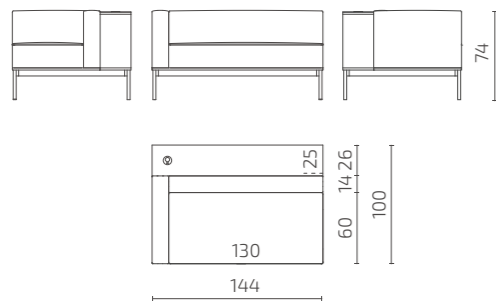

S126-2CLC

Right corner module 2-Seat with back shelf only

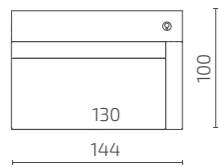

S126-2CRC

All dimensions provided in centimetres.

Left corner module 2-Seat

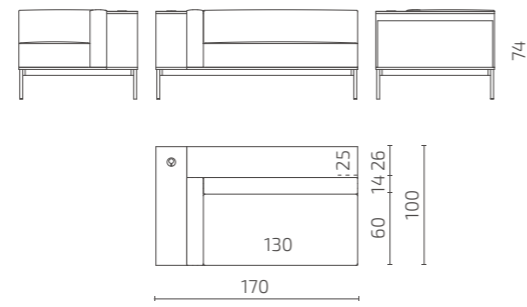

S126-2CLB

Right corner module 2-Seat

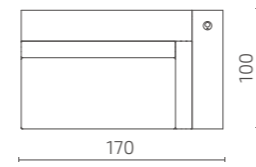

S126-2CRB

Table module

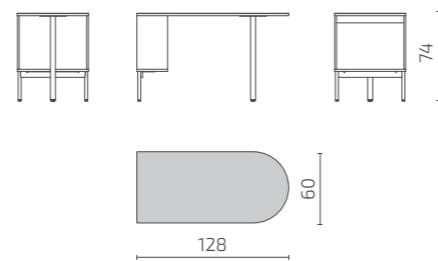

S126-T1

## MODULES

Corner module 1-Seat



Corner module 2-Seat



Corner module 2-Seat with back shelf only



Table module



## SAMPLE COMBINATIONS



# Wander

## Cosy niche sofa

Design: Lauri Visnapuu

When you combine the comfort of a home sofa with the convenience of an office sofa, you get Wander – a cosy niche sofa with high walls that provides visual separation, supports productivity, and can be easily moved around.

With modules available in three different widths, Wander offers a number of interior design options. By placing the modules opposite each other, the result is a cosy nest suitable for a private chat. When complemented with an auxiliary desk, it serves as a functional work island. Equipped with castors, Wander moves with you. Modules arranged in a row are also suitable, for a café, for example.

Wander's soft back cushions are loose and adjustable. In keeping with circular economy design, Wander's coverings are durable and easy to replace, even on your own.



Welcome Zone



Social Zone



Collaboration Zone



Concentration Zone

Can be moved around, if desired

Help make waiting more comfortable

Allows you to focus and separate

## PRODUCT INFORMATION

### Versions

Available in 3 different sizes. Additionally available as Workbays in 3 different sizes when connected with compound wall

### Legs

Lockable 360° rotating castors

### Accessories

Workbays' compound walls are equipped with tables to add functionality to the seating area

### Electrical outlet

Integrated electrical outlet

### Warranty

5 years

### Sustainability

Based on principles of the circular economy

### Certification



## STANDARD MATERIALS

### Frame

Solid wood and plywood

### Seat and backrest

Durable HR foam; fire retardant HR foam on request

### Tables

Matt high-pressure laminate top with powder-coated metal leg

### Pillows

Feather filling, attached with Velcro

### Fabric upholstery

The cover fabric is not removable

For extra acoustic attenuation acoustic fabrics recommended  
Choose any fabric from Intuit **Standard Fabric Collection**

### Additional information

As part of after-sales service we offer the change of cover fabric and all other components if needed



## FINISHING OPTIONS

### Tabletop

#### High-pressure laminate

Black



### Table leg

#### Powder-coated metal

Jet Black RAL 9005



Other finishing options available on request.



## ELECTRICAL OUTLET



220V + USB A & C

Other electrical outlet combinations available on request.

**Berker Integro Flow**  
Color: Anthracite Matt

Available options DK, EU, FR, UK



## DIMENSIONS

Seat depth: 46 cm, without pillow 63 cm  
Seat height: 46 cm

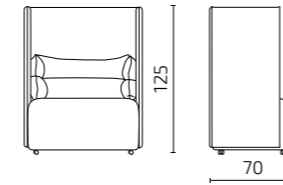

**S129-S1H3**

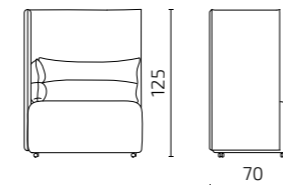
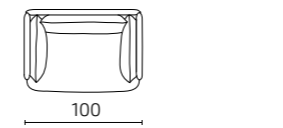

**S129-1CLH3**

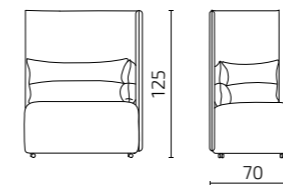

**S129-1CRH3**

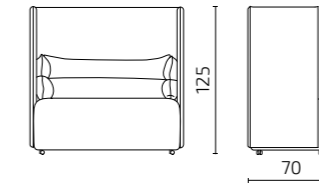
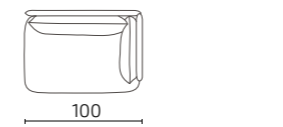

**S129-S2H3**

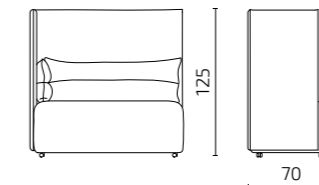
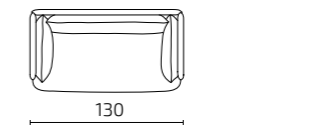

**S129-2CLH3**

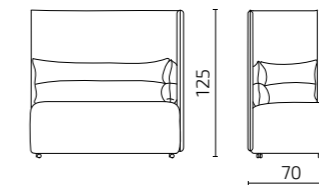

**S129-2CRH3**

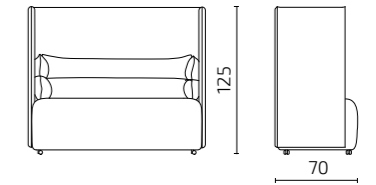
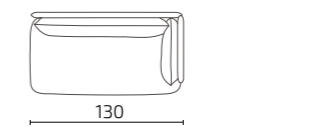

**S129-S25H3**

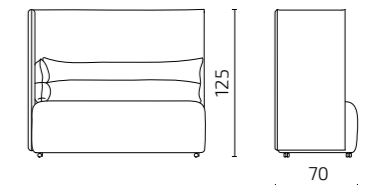
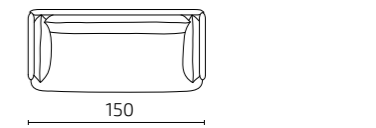

**S129-25CLH3**

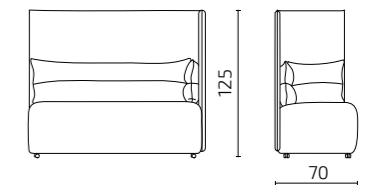

**S129-25CRH3**

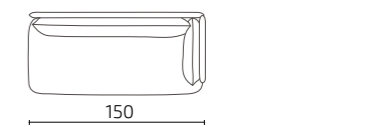

### Tables

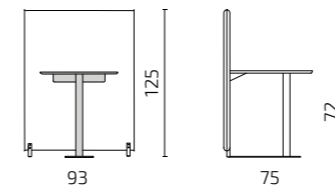

**S129-WH3T1**

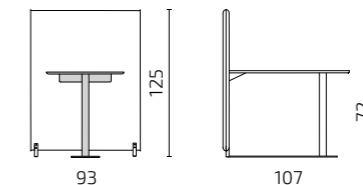
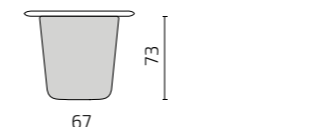

**S129-WH3T2**

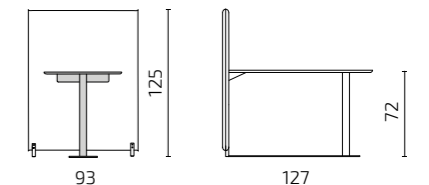
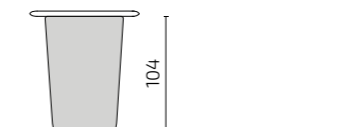

**S129-WH3T25**



All dimensions provided in centimetres.

# Intuit Booth

Available at  

## Phonebooth

Design: Iseasi



You need to make a call. But you'd rather the whole office didn't listen in. Booth provides a quiet oasis, so you can focus on your conversation, without distractions.

We saw an opportunity to make the basic phone booth a much more pleasant place to be. If you've spent time in cramped and claustrophobic phone booths before, you'll marvel at how Booth opens up the space. You can be part of the open-plan space, while still having access to the focus and privacy you need at various points of your day. And its rocking and rotating seat gives you room to move, without banging your elbows on the walls every 5 seconds.

Booth harnesses technology and design to provide an intuitive space for your special task. With sound absorbing upholstery and acoustic panels, Booth dampens noise from every direction. Its motion sensor fresh air ventilation system and adjustable LED lighting help you create exactly the environment you work well in. While its wheels mean you can relocate it to anywhere in your office.



Concentration Zone

Enjoy a room that feels bigger on the inside

Find the peace you need

Take calls without disturbing your team

## PRODUCT INFORMATION

### Acoustics

Sound absorption class A

### Movable

On four wheels underneath, floor adjusters are integrated for levelling

### Integrated ventilation

Airflow rate: when occupied 40l/s; stand-by mode, after 5 mins no occupancy 27 l/s

### Accessories

Bar height perch, 360° swivel and rocking

### Electrical outlet

Integrated electrical outlet

### Warranty

5 years

### Sustainability

Based on principles of the circular economy

### Test & Certification

Sound absorption class B



## STANDARD MATERIALS

### Structure

High-quality plywood, painted black

### Outside

Soft upholstered panels covered with any felt fabric

### Inside

Ceiling and wall panels covered with certified acoustic and fire-retardant felt and fabric

### Floor

Carpet tile in a fishbone pattern

### Glass door and back wall

442 laminated and tempered clear glass with sound control PVB interlayer

### Bar height perch

Durable HR-foam, fabric; powder-coated matt metal legs; tilting base

### Fabric upholstery

Choose any felt from **Intuit Standard felt selection**

### Additional information

As part of after-sales service we offer the change of cover fabric and all other components if needed

Utilitas Wind office in Tallinn, Estonia. Photo: Märt Lillesiim



## INSIDE COVER MATERIALS

### Walls

#### Pressed felt

Dark Grey



Other finishing options available on request.

### Floor

#### Carpet tile

Grey



## ELECTRICAL OUTLET

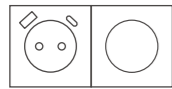

220V + USB A & C + Dimmer

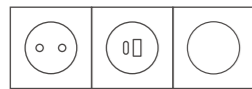

220V + USB A & C + Dimmer

### Jung LS

Color: Anthracite Matt

Available options EU, FR

### Jung LS

Color: Anthracite Matt

Available options UK

### Gira

Color: Anthracite Matt

Available options DK

Other electrical outlet combinations available on request.

## DIMENSIONS

### Phonebooth

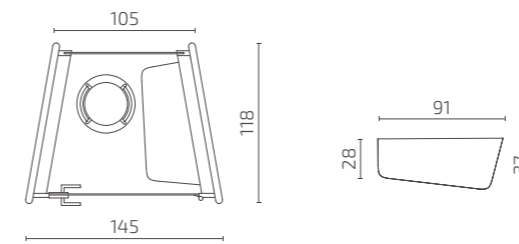
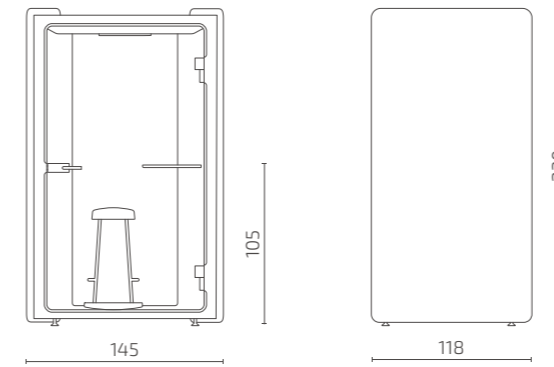

### S122-B00TH1

All dimensions provided in centimetres.

### Bar height perch

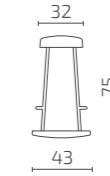

### S122-BFL1

### More Space

Booth's trapezoid shape is especially designed to feel spacious. It enables you to choose different positions. Its wide glass panels help you feel part of your wider surroundings, without being disturbed by them. And make the whole booth full of light. You can swing and turn on your chair, adapting your setup to whatever you need to work on.

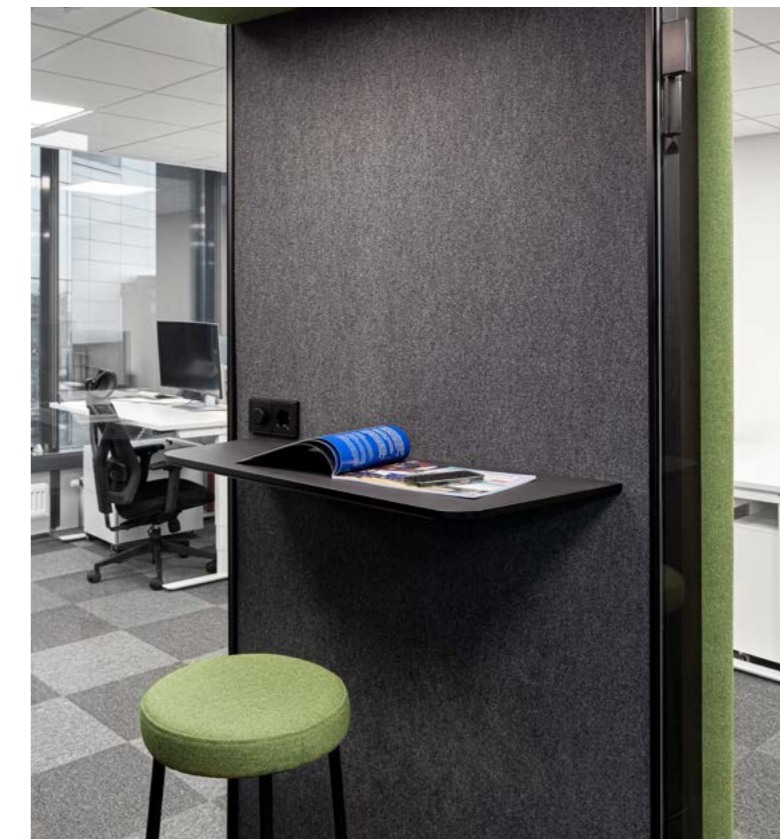

# Aide

## Multifunctional table series

Design: Karl Kukkk

The Aide table is an indispensable backdrop, designed to complement room layouts and core furniture. The multi-functional table series comprises variations that are tall, low, slender, sturdy, spacious, compact, and offer a combination of features, totalling 6 different versions.

With its timeless and refined appearance, Aide blends into any interior, while maintaining an understated presence, allowing other furniture pieces to take the spotlight. Aide focuses on function adapting to various environments – it can be a coffee table in the lounge area, a dining table in cafes and canteens, or a desk in the work zone. Finding the perfect solution is easy, as Aide can be integrated with the entire Intuit soft furniture range.



Welcome Zone



Social Zone



Collaboration Zone



Concentration Zone

Easy to combine with other furniture

Can serve several functions

Always blends stylishly into the interior

## PRODUCT INFORMATION

### Versions

Available in 2 different heights and 3 different sizes

### Warranty

5 years

### Sustainability

Based on principles of the circular economy

### Certification



## STANDARD MATERIALS

### Tabletop

Matt high-pressure laminate

### Legs



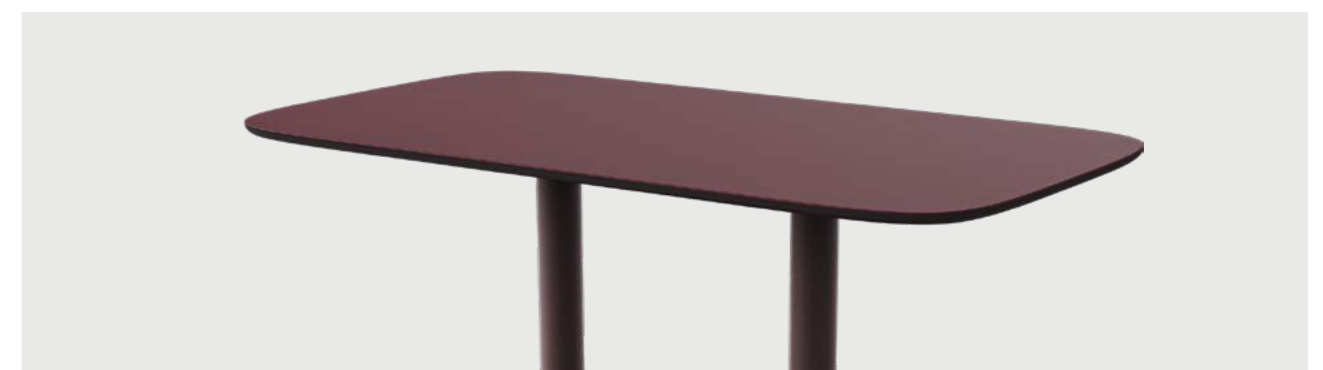

Powder-coated metal



## FINISHING OPTIONS

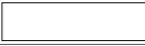



### Tabletop

#### High-pressure laminate

Alpine White Egger W1100 PM	
Soft Black Egger U899 PM	
Stone Green Egger U665 PM	
Garnet Red Egger U399 PM	

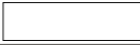
### Legs

#### Powder-coated metal

Signal White RAL 9003	
Jet Black RAL 9005	
Tarpaulin Grey RAL 7010	
Black Red RAL 3007	

## DIMENSIONS

### Cafeteria or work tables

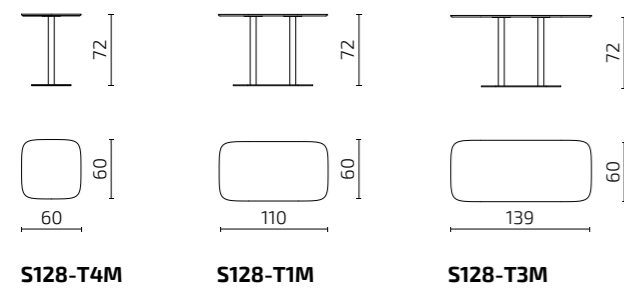

### Sofa tables

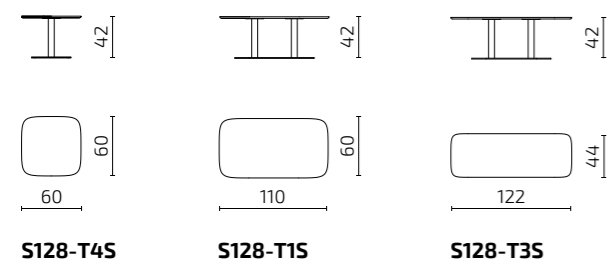

All dimensions provided in centimetres.

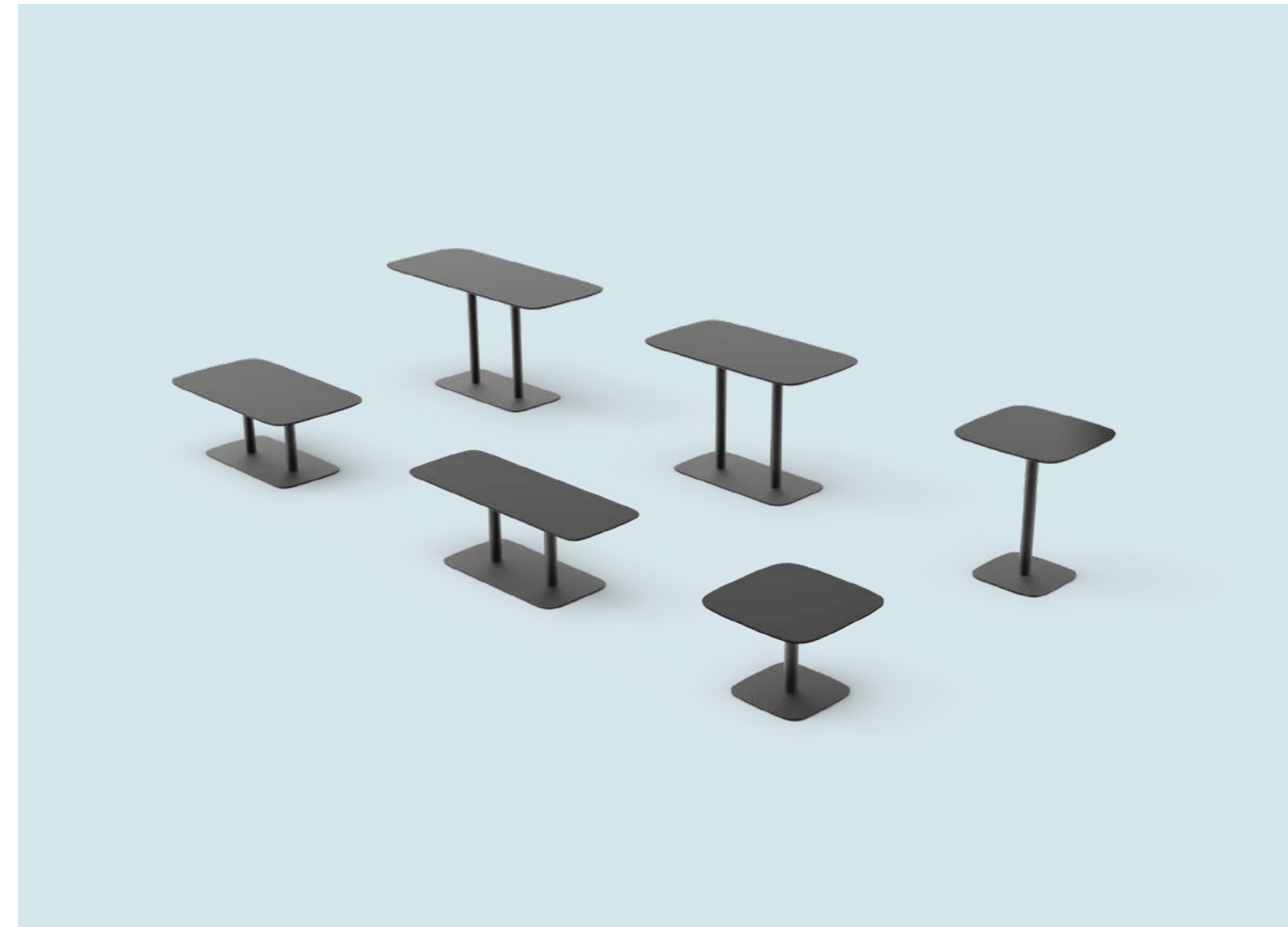

# Alfred

## Side table

Design: Argo Tamm

Make it easy for your visitors by giving them somewhere to pop their coffee or the piles of notes resting on their lap.

Add its subtle and stylish design to the smaller Social areas you've dotted around the office, and your team can put down their drinks and connect with a quick midday chat.



Welcome Zone



Social Zone



Collaboration Zone

Break up a row of sofas

Make your spaces inviting and practical

## PRODUCT INFORMATION

### Versions

Available in 2 different heights

### Warranty

5 years

### Sustainability

Based on principles of the circular economy

### Certification



## STANDARD MATERIALS

### Tabletop and leg

Solid wood oak

### Base

Powder-coated metal

## FINISHING OPTIONS

### Tabletop and leg

#### Solid oak

Whitened

Natural

Wenge

Black



#### Base

#### Powder-coated metal

Umbra Grey RAL 7022

Jet Black RAL 9005



Other finishing options available on request.



## DIMENSIONS

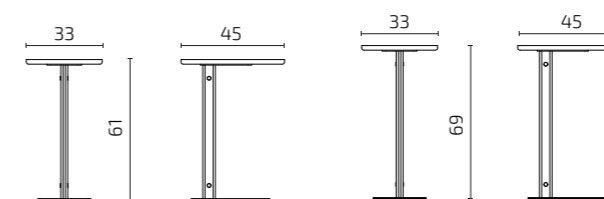

S61-T61T

S61-T69T

All dimensions provided in centimetres.



# Flow

## Shared office desk

Design: Martin Pärn / Janno Nõu, Iseasi

Sometimes, only a few people come into the office and the room feels empty. Other times, when everyone is there – management, busy bees, guests – it could get a little crowded. With Flow, a shared office desk, neither loneliness nor a lack of space is never an issue

Flow is the social centre of the room, providing an equally welcoming haven for colleagues without a fixed desk as well as for groups holding meetings. The hidden sockets in the table's shelf supports enable one to be productive. It is also an ideal place for team lunches and casual chats. Flow stands without screws on stylish trestles, allowing you to effortlessly give the room a different look with a reversible two-tone tabletop.



Social Zone



Collaboration Zone

Bring people together

Complements an otherwise empty space

A work and a meeting table

## PRODUCT INFORMATION

### Versions

Available in 2 lengths

### Accessories

Shelf

Under table screen for the wiring

### Electrical outlet

Integrated in the table top (available only for the table with shelf)

### Warranty

5 years

### Sustainability

Based on principles of the circular economy

### Certification



## STANDARD MATERIALS

### Table top

High-pressure laminate or melamine with ABS oak edge band

### Legs

Solid oak

### Metal parts

Powder-coated metal

### Under table screen

Recommended material: any felt fabric from our Standard Fabric Collection

### Additional information

As part of after-sales service we offer the change of cover fabric and all other components if needed



## FINISHING OPTIONS

### Tabletop

#### High-pressure laminate, ABS oak edge band

Garnet Red Egger U399 ST9  
Antique Rose Egger U325 ST9



Indigo Blue Egger U599 ST9  
Cashmere Grey Egger U702 ST9



#### Melamine, ABS oak edge band

Classic White W960 ST7  
Classic Black U999 ST7



Other finishing options available on request.

### Legs

#### Solid oak

Natural



#### Metal parts

##### Powder-coated metal

Jet Black RAL 9005



Grey Blue RAL 5008



Black Red RAL 3007



## DIMENSIONS

### Table without shelf

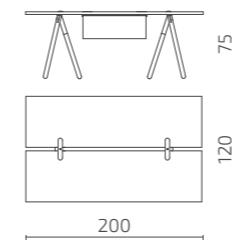

S127-TL200 (laminata)  
S127-TM200 (melamina)

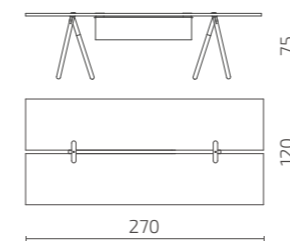

S127-TL270 (laminata)  
S127-TM270 (melamina)

### Table with shelf

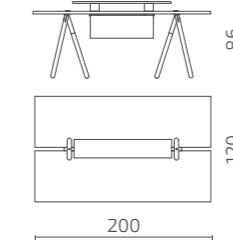

S127-TL200 + S127-TRL (laminata)  
S127-TM200 + S127-TRM (melamina)

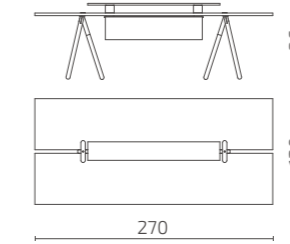

S127-TL270 + S127-TRL (laminata)  
S127-TM270 + S127-TRM (melamina)

All dimensions provided in centimetres.

## ELECTRICAL OUTLET

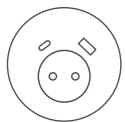

**Powerdot 16**  
Color: Black Matt

Available options DK, EU, FR

220V + USB A & C

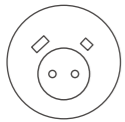

**Powerdot 12**  
Color: Black Matt

Available options UK

220V + USB A + data

Other electrical outlet combinations available on request.

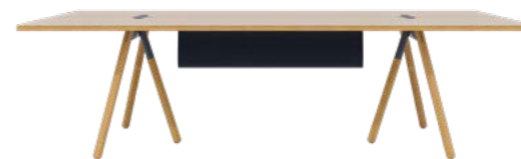

# Kuubik

## Sofa table

Design: Argo Tamm

Make it easy. Kuubik is no ordinary table. It's modern cube design means it doesn't impose on its environment.

Use Kuubik to divide up the seating in your reception area, or place them around the office paired with our compact Intro armchair.



## PRODUCT INFORMATION

### Versions

Available in 3 different sizes

### Warranty

5 years

### Sustainability

Based on principles of the circular economy

## STANDARD MATERIALS

### Tabletop

Mass-colored wood fibreboard / Veneered MDF board

### Frame

Powder-coated metal

Postimees office in Tallinn, Estonia



Welcome Zone



Social Zone

Bring a little interest to your reception

Encourage inspiring coffee breaks

## FINISHING OPTIONS

### Tabletop

#### Veneered MDF board

Natural oak



#### Mass-colored wood fibreboard

Black



Other finishing options available on request.

### Frame

#### Powder-coated metal

Jet Black RAL 9005



## DIMENSIONS

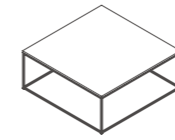

S56-TLK

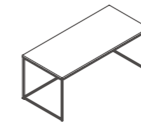
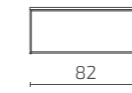
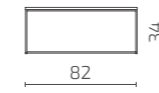

S56-TMA

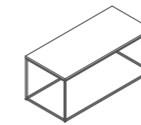
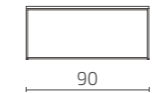

S56-TMK

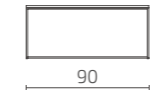

S56-TSA

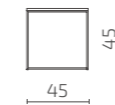

S56-TSK

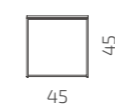

All dimensions provided in centimetres.



# Kuubik

## Side table

Design: Intuit design team

Kuubik side table is a small table of just the right height and weight to pull over your lap while working with the laptop on the couch. The side table is also a comfortable place next to the sofa to place a cup of coffee or a notebook.

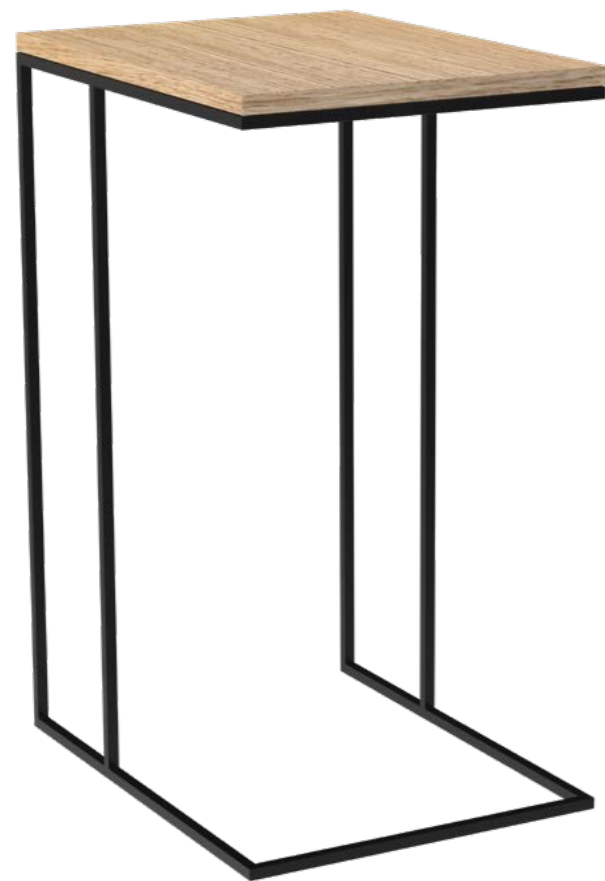

Welcome Zone



Social Zone



Concentration Zone

Give a practical addition to the sofa

Add comfort when working with a laptop on the couch

## PRODUCT INFORMATION

### Versions

Available in 3 different sizes

### Warranty

5 years

### Sustainability

Based on principles of the circular economy

## STANDARD MATERIALS

### Tabletop

Mass-colored wood fibreboard / Veneered MDF board

### Frame

Powder-coated metal

## FINISHING OPTIONS

### Tabletop

#### Veneered MDF board

Natural oak



#### Mass-colored wood fibreboard

Black



### Frame

#### Powder-coated metal

Jet Black RAL 9005



Other finishing options available on request.

## DIMENSIONS

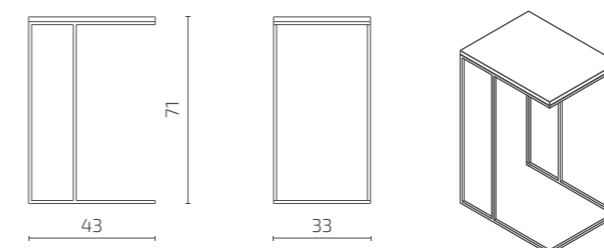

S56-TAB1

All dimensions provided in centimetres.

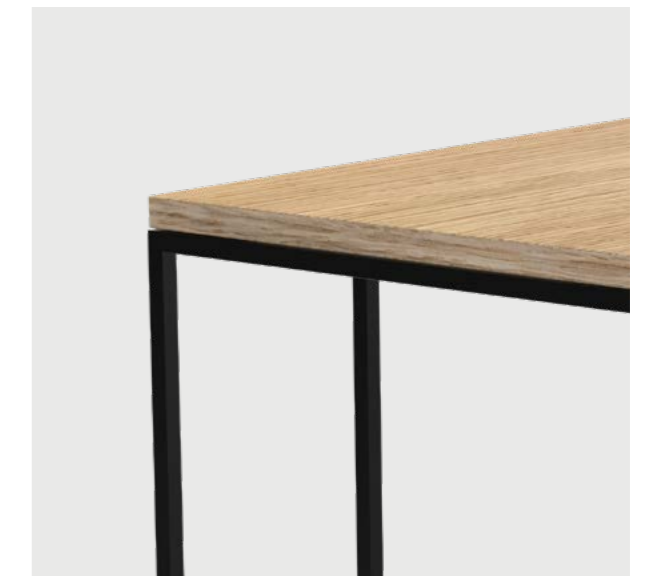

# Rolf

Available at  
**pCon**  
PLANNER

## Mobile table

Design: Iseasi

Keep your conversations agile. A table for flexible collaboration. Designed for ease of movement with its attached wheels and sturdy oak frame, with a height that makes stand-up meetings a breeze. Use these on their own, or push them together to create different configurations. Bar stool height, and always ready for when inspiration strikes, pull over the Rolf and get collaborating.



Collaboration Zone

Make your office flexible

Encourage active problem-solving

Bring heads together at a moment's notice

## PRODUCT INFORMATION

### Warranty

5 years

### Legs

2 castors, Ø 10 cm

### Sustainability

Based on principles of the circular economy

### Certification

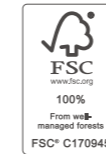

Vitronic office in Wiesbaden, Germany  
Photo: Sergey Melnikov

## STANDARD MATERIALS

### Tabletop

High-pressure laminate with natural oak edge band

### Legs

Solid oak

## FINISHING OPTIONS

### Legs

#### Solid oak

Natural



### Tabletop

#### High-pressure laminate, natural oak edge band

Black



White



Other finishing options available on request.

## DIMENSIONS

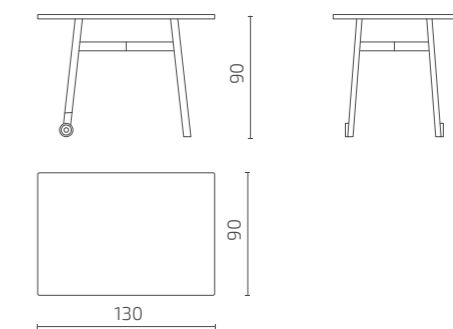

S109-T130

All dimensions provided in centimetres.

# Grow

Available at  
**pCon**  
 PLANNER

## Mobile plant divider

Design: Lauri Visnapuu

Transform the office into a lush forest and show your commitment to employee well-being. Grow's flowerpots of three different heights act as smart space dividers, offering a secluded retreat from the endlessness of the open office floor plan. Equipped with 360-degree rotating wheels, these planters allow you to refresh the office landscape with a new floral arrangement at your whim.

For added versatility, Grow absorbs office noise and fosters a tranquil environment for the team. Alternatively, choose a multifunctional design featuring a spacious shelf on one side, blending utility with natural beauty.

## PRODUCT INFORMATION

### Versions

Available in 3 different heights

### Acoustics

Sound absorption class D

### Legs

360° rotating and lockable castors

### Warranty

5 years

### Sustainability

Based on principles of the circular economy

### Test & Certification

Acoustic absorption test - Class D



## STANDARD MATERIALS

### Walls

Veneered MDF board, covered with fabric from one or both sides upon request

### Shelving (on models with shelves)

Veneered MDF board

### Legs

Powder-coated metal

### Plant box

Powder coated waterproof steel

### Fabric upholstery

Choose any fabric from **Intuit Standard Fabric Collection**

### Additional information

As part of after-sales service we offer the change of cover fabric and all other components if needed

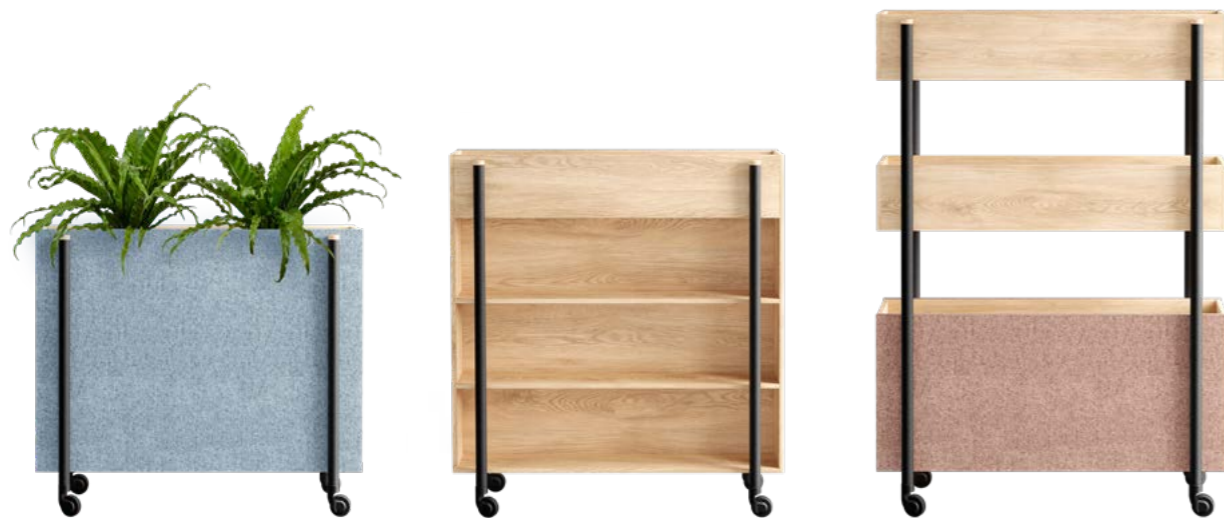

Welcome Zone



Social Zone



Collaboration Zone



Concentration Zone

Construct inspiring private spaces

Improve office acoustics

Bring greenery into the office

The top part of Grow features an integrated waterproof metal box for safe watering of plants.

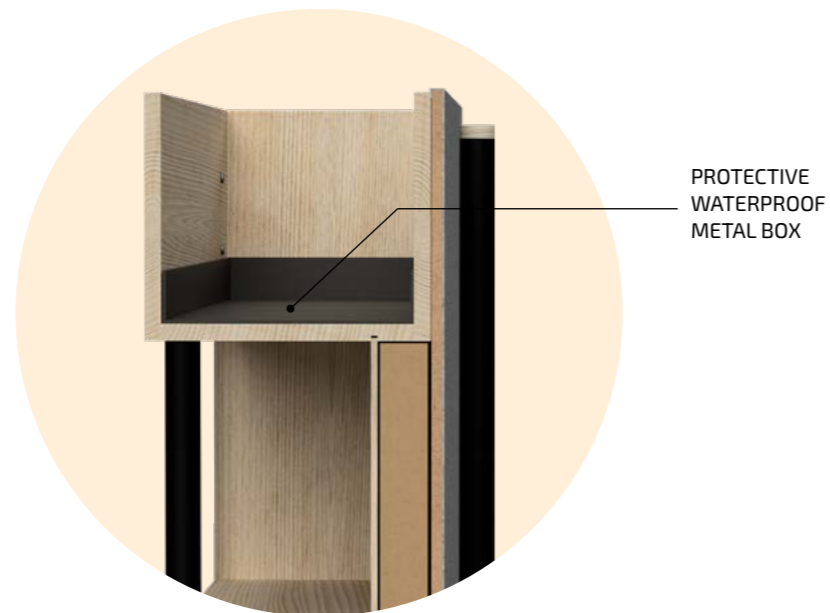

PROTECTIVE WATERPROOF METAL BOX

## DIMENSIONS

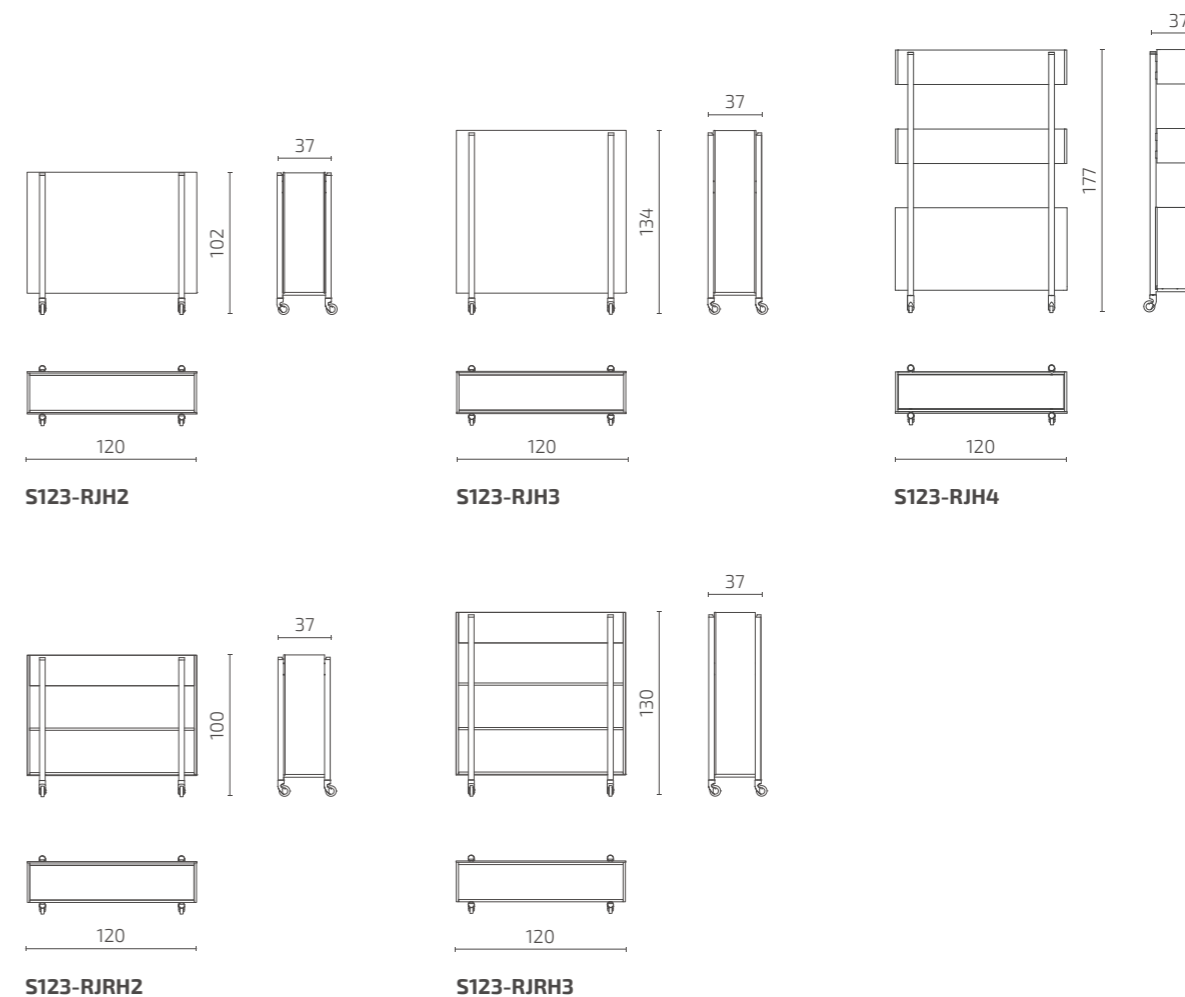

All dimensions provided in centimetres.

## FINISHING OPTIONS

### Shelving and walls

#### Veneered MDF board

Natural oak



### Legs

#### Powder-coated metal

Jet Black RAL 9005



Other finishing options available on request.





# Hover

## Leaning wall

Design: Karl Kukkk

Sometimes, there's not enough space for a comfortable sofa, but you still want to make waiting comfortable. The day is saved by the soft leaning wall Hover, which you can lean on to pass the time alone or chatting with a companion.

Hover is brilliantly space-saving and fits perfectly in places where you might need to stand, such as at the airport, in a corridor, or behind a meeting room door. Placed in the office kitchen or in an

in-between space, it provides a convenient spot for exchanging ideas with a colleague on the go. Hover is available as a module in four different sizes. By adding a coffee table and a power socket, you can even get work done while leaning. Quickly installable and featuring easily replaceable fabric, Hover also offers noise-dampening properties thanks to its foam and perforated inner panel. Hover is designed for disassembly fully embracing the principles of circular design.

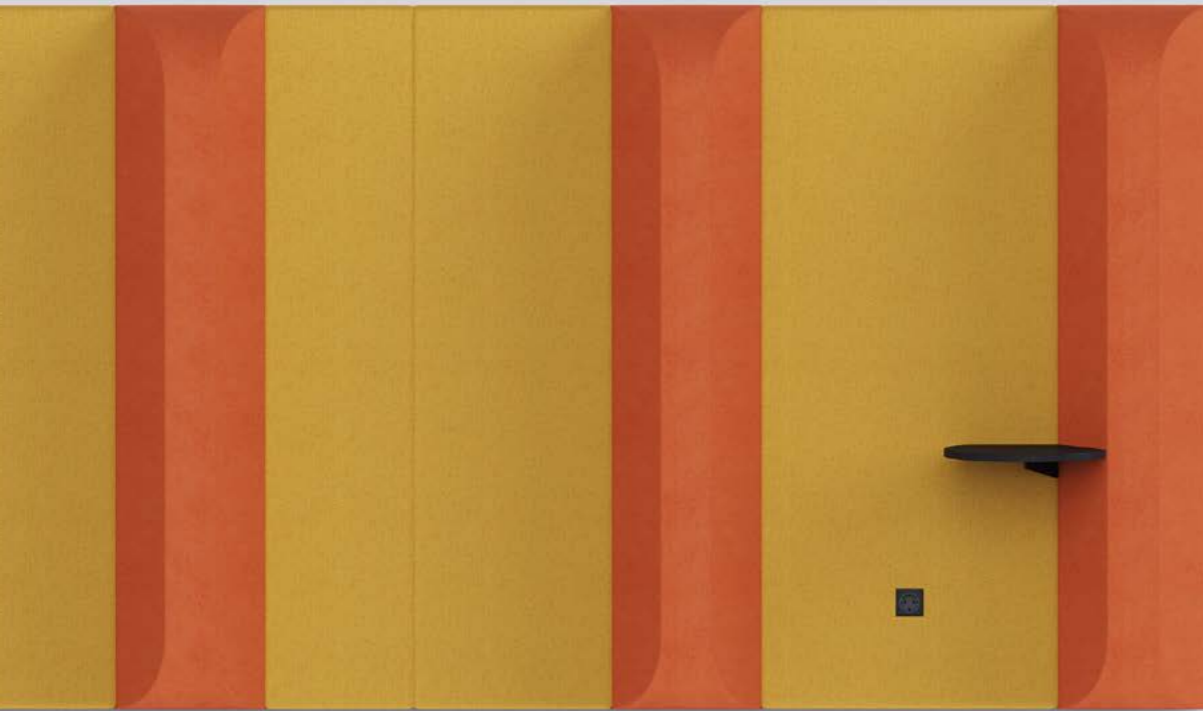

Welcome Zone



Social Zone

Enable to have quick conversations

Save space, adding cosiness to the milieu

Help make waiting more comfortable

## PRODUCT INFORMATION

### Versions

Available in 4 different modules

### Acoustics

Sound absorption class B

### Accessories

Tables to add functionality to the standing area

### Electrical outlet

Integrated electrical outlet

### Warranty

5 years

### Sustainability

Embraces the principles of circular design

### Test & Certification

Acoustic absorption test - Class B



## STANDARD MATERIALS

### Frame

Solid wood slats, perforated MDF-plate

### Mounting

Metal profiles, button-fix

### Backrest

Durable HR foam; fire retardant HR foam on request

### Tables

Mass-colored wood fibreboard top

### Fabric upholstery

The cover fabric is removable

Choose any fabric from **Intuit Standard Fabric Collection**

### Additional information

As part of after-sales service we offer the change of cover fabric and all other components if needed



## CIRCULAR DESIGN

Designed for disassembly fully embracing **the principles of circular design.**

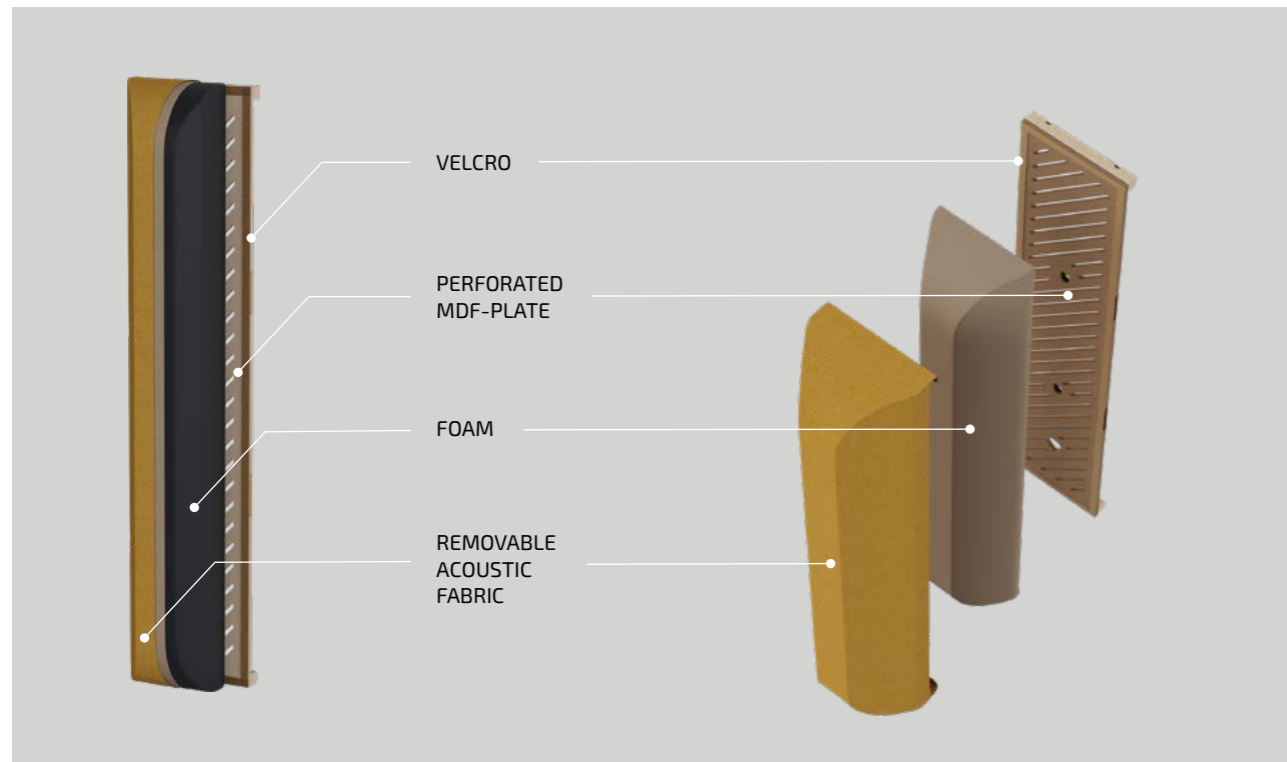

## FINISHING OPTIONS

### Table

**Mass-colored wood fibreboard**

Grey

Black



Other finishing options available on request.



## ELECTRICAL OUTLET



**220V**

**Berker Integro Flow**  
Color: Anthracite Matt

Available options DK, EU, FR, UK



**USB A & C**

**Berker Integro Flow**  
Color: Anthracite Matt

Available options DK, EU, FR, UK

Other electrical outlet combinations available on request.

## DIMENSIONS

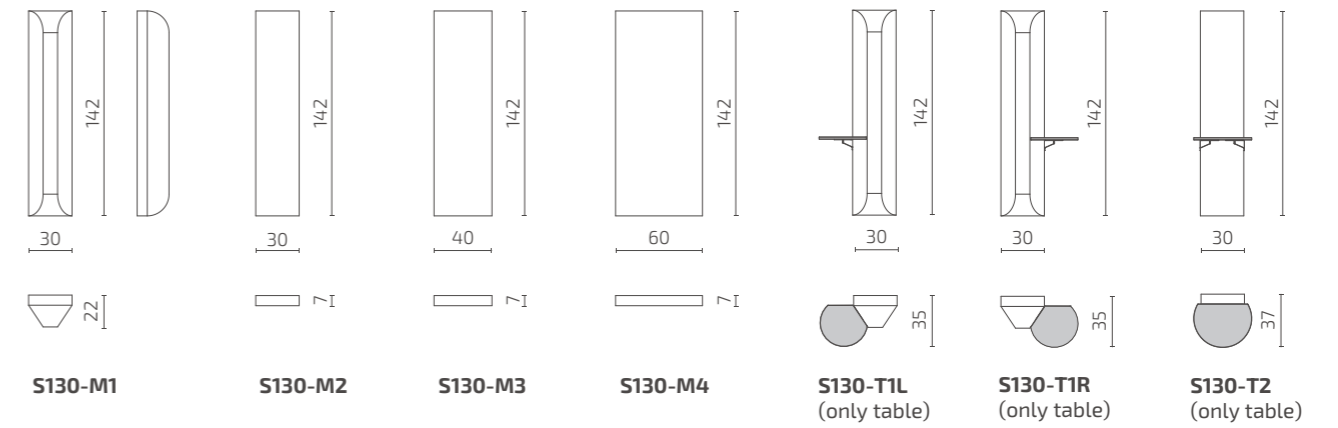

All dimensions provided in centimetres.

## SAMPLE COMBINATIONS



# Note

## Mobile whiteboard

Design: Lauri Visnapuu

Make room for big ideas. Use our convenient mobile whiteboard to utilise every brainstorming opportunity. Equipped with 360-degree wheels, you can take the whiteboard wherever fresh ideas are born.

The back of the whiteboard is optionally covered with cutting-edge acoustic felt. Given its sound-absorbing qualities and notable height, the board can be transformed into a privacy screen, showcasing our love for multifunctional furniture.



Collaboration Zone



Concentration Zone

Minimize workplace noise

Divide your office on the go

Wheel the board around for creative collaboration

## PRODUCT INFORMATION

### Warranty

5 years

### Legs

360° rotating and lockable castors

### Sustainability

Based on principles of the circular economy

### Certification



## FINISHING OPTIONS

### Legs

#### Powder-coated metal

Jet Black RAL 9005

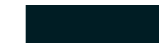

Other finishing options available on request.

## DIMENSIONS

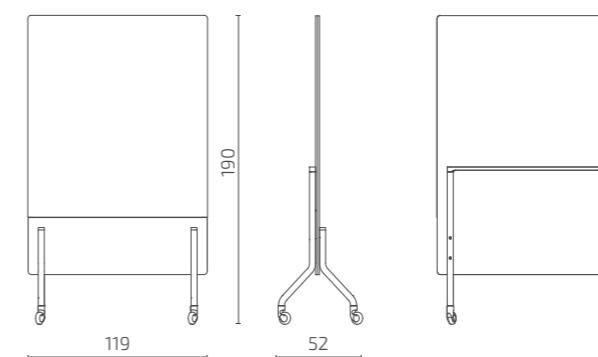

S124-MWH190

All dimensions provided in centimetres.

## STANDARD MATERIALS

### Whiteboard

High-pressure decorative laminate

### Panel

MDF, upholstered with batting and covered with acoustic felt on request

### Legs

Powder-coated metal

### Marker Holder

Varnished solid oak

### Fabric upholstery

The cover fabric is not removable

Choose any fabric from **Intuit Standard Fabric Collection**

### Additional information

As part of after-sales service we offer the change of cover fabric and all other components if needed



# Silent Note

## Mobile room divider

Design: Lauri Visnapuu

Shape your world the way you want it. Use this mobile room divider to create a separate space in an open office exactly where you need it. Equipped with 360-degree rotating wheels, it moves easily to the work rhythm of your team.

Silent Note belongs to the Note product family and comes covered with fabric on both sides, offering unlimited possibilities for its unique design. To increase the sound absorbing properties, we recommend using an acoustic felt as a cover.



Collaboration Zone



Concentration Zone

Minimize workplace noise

Divide your office on the go

Wheel the room divider around for creative collaboration

## PRODUCT INFORMATION

### Warranty

5 years

### Legs

360° rotating and lockable castors

### Sustainability

Based on principles of the circular economy

### Certification



## FINISHING OPTIONS

### Legs

#### Powder-coated metal

Jet Black RAL 9005

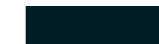

Other finishing options available on request.

## DIMENSIONS

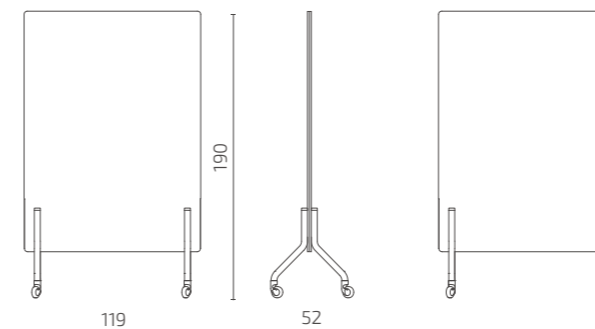

S124-WH190

All dimensions provided in centimetres.

## STANDARD MATERIALS

### Panel

MDF, upholstered with batting and covered with acoustic felt on request

### Legs

Powder-coated metal

### Fabric upholstery

The cover fabric is not removable

Choose any fabric from **Intuit Standard Fabric Collection**

### Additional information

As part of after-sales service we offer the change of cover fabric and all other components if needed



# Oaas

## Planter room divider

Design: Lauri Visnapuu

Character lies in the details. The small, seemingly insignificant elements that give a space its unique identity. The best details don't just enhance aesthetics – they add value!

The Oaas decorative room divider is a stylish and functional backdrop that brightens any room, regardless of size. Its elegant round modules can stand alone or be connected to form 'walls', creating purposeful zones within a space. Designed with practicality in mind, Oaas features a surface perfect for displaying plants or decorative objects. Plus, its fabric-covered outer wall improves acoustics by absorbing echoes.



Welcome Zone



Social Zone



Collaboration Zone



Concentration Zone

Allow the room to be divided into zones

Reduce noise and echoes

Add variety to the room

## PRODUCT INFORMATION

### Versions

Available as a surface or plant pedestal modules in 7 different heights

### Modularity

Modules can be connected together

### Warranty

5 years

### Sustainability

Based on principles of circular economy

### Certification



## STANDARD MATERIALS

### Frame

MDF, carton

### Sole

Felt sole

### Surfaces

Mass-colored wood fibreboard top

### Inside plant pedestals

Water and dirt retardant vinyl / urethane fabric

### Fabric upholstery

The cover fabric is removable

Choose any felt from **Intuit felt selection**

### Additional information

As part of after-sales service we offer the change of cover fabric and all other components if needed



## FINISHING OPTIONS

### Surface

*Mass-colored wood fibreboard*

Black



Other finishing options available on request.



## SAMPLE COMBINATIONS

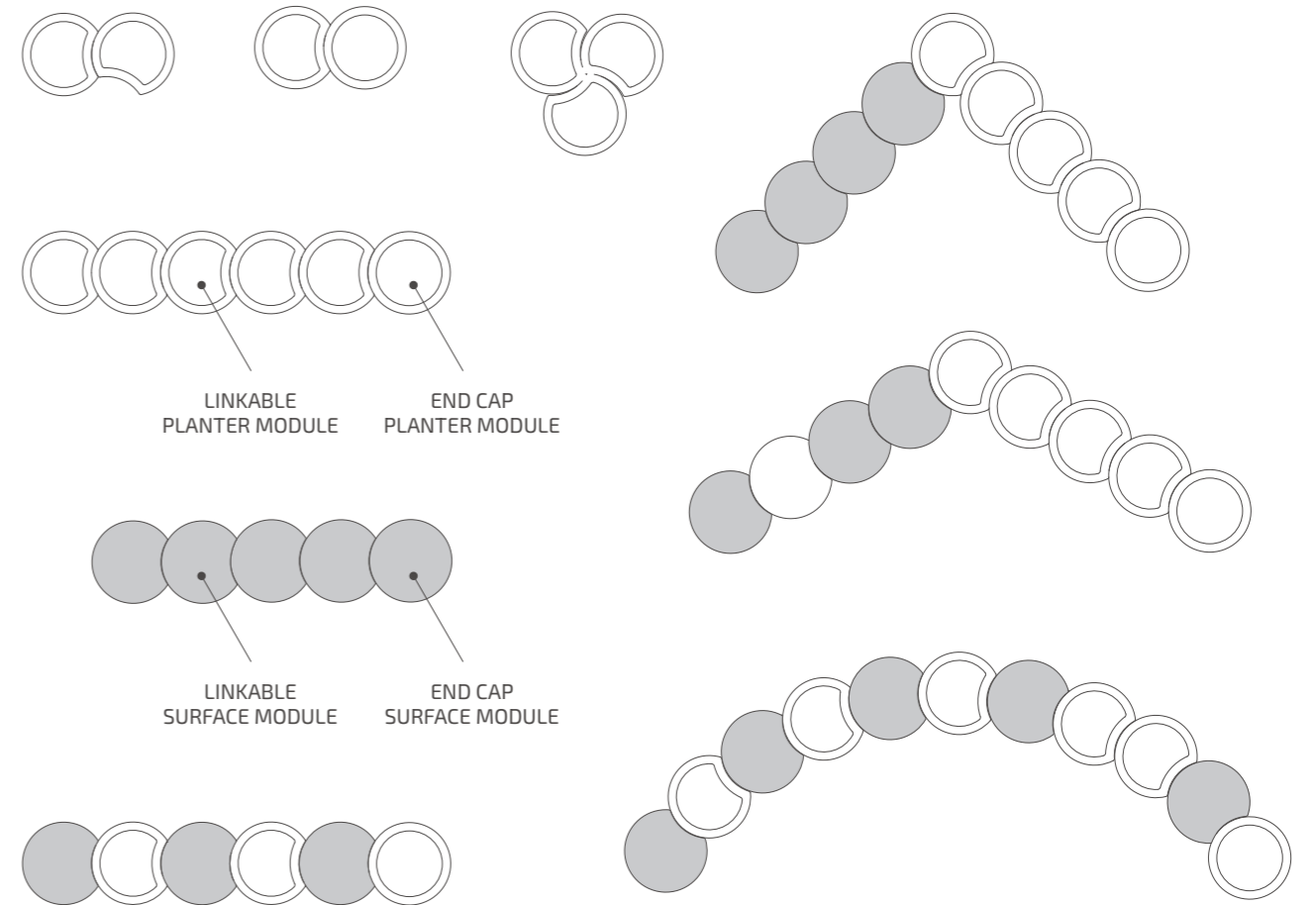

## DIMENSIONS

### Linkable surface module

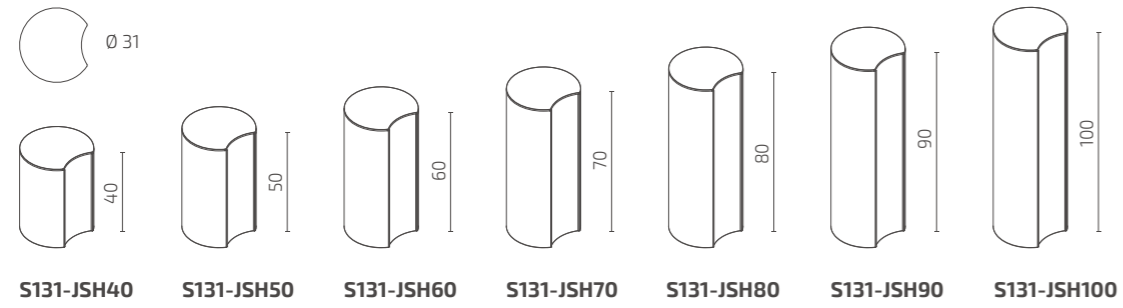

### Linkable planter module

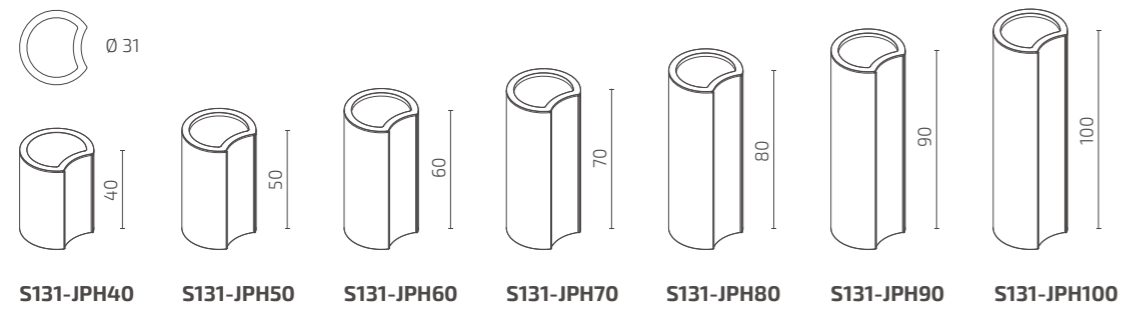

### End cap surface module

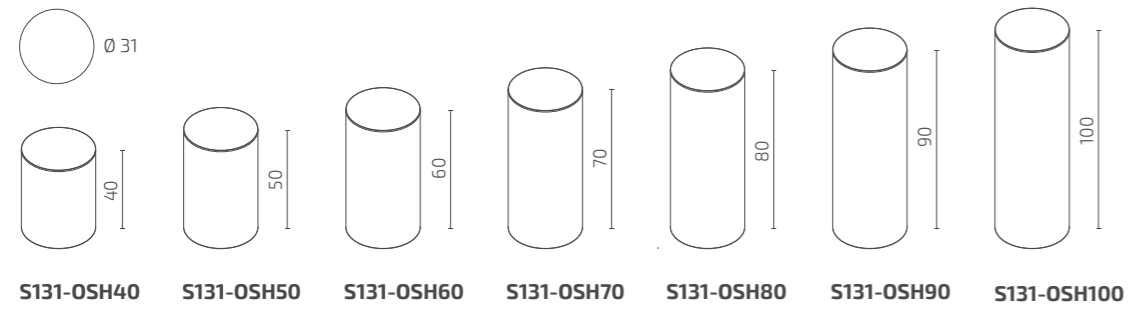

### End cap planter module

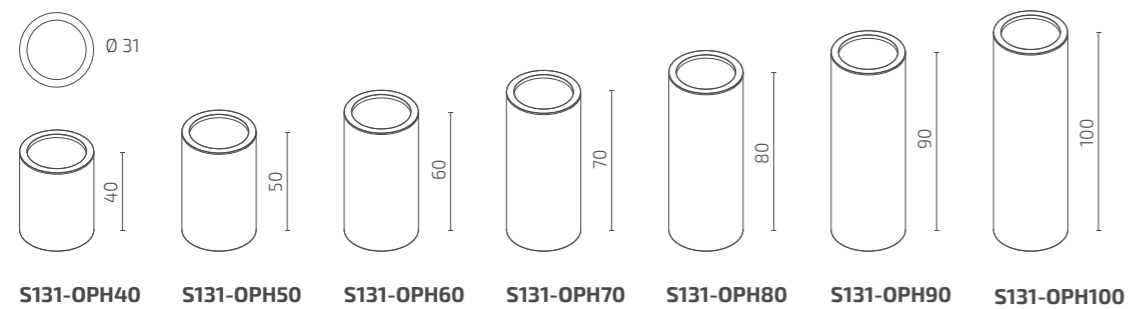

All dimensions provided in centimetres.



# Sigmund

Available at  
**pCon**  
PLANNER

## Sound-absorbing screen

Design: Pent Talvet, Iseasi

The office of the future is agile and flexible. When you need to change the use of a space without knocking down walls, then you need Sigmund. This ingenious sound-absorbing screen can make any area feel like a private office.

Create a smaller Collaboration Zone within an open-plan space, or curate an enclosed seating area. Wherever the flow of your workplace, Sigmund can help you intuitively meet the needs of your team. Without having to don a hard hat.



Social Zone



Collaboration Zone



Concentration Zone

Easily display information

Deal with background noise

Create a quiet corner

Divide your open space

## PRODUCT INFORMATION

**Warranty**  
5 years

**Legs**  
360° rotating wheels

**Sustainability**  
Based on principles of the circular economy

### Certification



## STANDARD MATERIALS

**Filling**  
Synthetic felt with sound-absorbing qualities; cotton batting; HR-foam

**Fabric upholstery**  
The cover fabric is not removable  
Choose any fabric from **Intuit Standard Fabric Collection**

**Additional information**  
As part of after-sales service we offer the change of cover fabric and all other components if needed

## DIMENSIONS

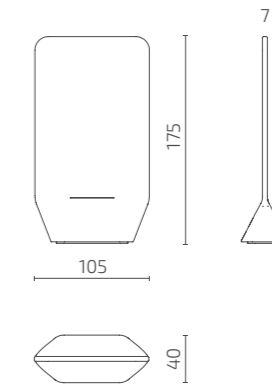

**S104-WH175**

All dimensions provided in centimetres.





## STANDARD FABRIC COLLECTION: A SYMPHONY OF DESIGN, DURABILITY AND SUSTAINABILITY

At Intuit by Softrend, we understand that the right fabric can transform a piece of furniture from merely functional to truly exceptional. That's why we offer an extensive Standard Fabric Collection, featuring over 1,000 high-quality fabrics sourced from renowned international suppliers including Camira, Kvadrat, Gabriel, and others. Each fabric is carefully selected to ensure it meets the rigorous demands of public spaces, with superior durability and compliance with flame and/or fire resistance standards.

Our collection is meticulously curated to cater to diverse tastes and budgets, organized into five distinct price categories. This structured assortment ensures that whether you're seeking luxury or affordability, you'll find fabrics that do not compromise on quality or style.

For those who desire a personal touch, we offer the flexibility to upholster your chosen furniture with your own material, allowing for a truly customized interior experience.

We are committed to sustainability; the majority of our fabrics bear the Oeko-Tex or Ecolabel certifications and/or are made from recycled materials, reflecting our dedication to environmental responsibility. Our annual update of the fabric selection not only aligns with the latest trends but also retains beloved classics that have stood the test of time.

Discover fabrics ranging from rich wools and sleek artificial leathers to soft felts, most backed by a 10-year manufacturer's warranty. The Intuit by Softrend Standard Fabric Collection is designed not just to meet, but to exceed the functional and aesthetic needs of any space.



# STANDARD FABRICS SELECTION 2025

## PRICE CATEGORY 1

Brand	Design	Martindale	Composition	Flammability standard				Sustainability	Other
				EN 1021 1 & 2	BS 5852		IMO		
					Part 1 0 & 1	Part 2 5 Crib			
Camira	<a href="#">Era CSE:</a> 01, 02, 21, 25, 31, 32, 34, 39, 41, 42	100 000	100% polyester	X		X			10 YEAR
Nevotex	<a href="#">Lido/Lido Trend</a>	115 000	100% polyester	Part 1 only	X				
Textum	<a href="#">Lotos</a>	100 000	80% PES 20% CO base fabric 100% PU surface		X				

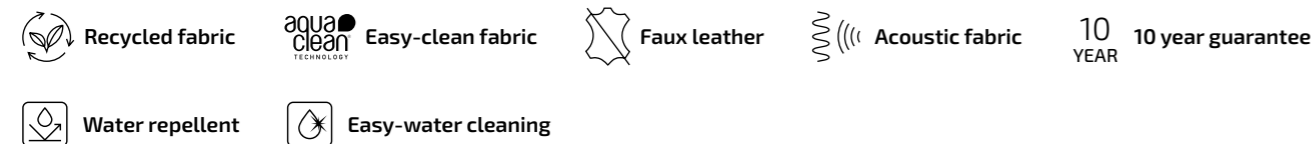

## PRICE CATEGORY 2

Brand	Design	Martindale	Composition	Flammability standard				Sustainability	Other
				EN 1021 1 & 2	BS 5852		IMO		
					Part 1 0 & 1	Part 2 5 Crib			
Blue Company	<a href="#">Dama</a>	> 60 000	70% wool 20% polyester 5% polyamide 5% acrylic (recycled wool)	X	X	X			
Camira	<a href="#">Era*</a>	100 000	100% polyester	X		X			10 YEAR
Camira	<a href="#">Vita</a>	100 000	Surface: 98% PVC 2% PU Substrate: 100% cotton	X		X	On request		
Camira	<a href="#">RePlay</a>	100 000	100% post-consumer recycled polyester	X		X			10 YEAR
Fabraa	<a href="#">Facet</a>	100 000	70% recycled wool 25% polyamide 5% blended fibre	X	X				
Fabraa	<a href="#">Forward</a>	100 000	50% recycled wool 30% linen 20% recycled polyamide	X	X				
Gabriel	<a href="#">Cura</a>	100 000	98% post-consumer recycled polyester 2% polyester	X	X				10 YEAR
Kvadrat	<a href="#">Autumn</a>	50 000	100% recycled polyester	X	X	X			10 YEAR
Kvadrat	<a href="#">Guest</a>	100 000	100% recycled polyester	X	X	X			10 YEAR
Nevotex	<a href="#">Wooly</a>	150 000	70% recycled wool 25% polyamide 5% blended fibre	X	X				
Textafoam	<a href="#">Aston</a>	70 000	100% polyester		X				

\* Except the fabric tones listed in Price category 1

PRICE CATEGORY 3

Brand	Design	Martindale	Composition	Flammability standard				Sustainability	Other
				EN 1021 1 & 2	BS 5852		IMO		
					Part 1 0 & 1	Part 2 5 Crib			
Agua	Taurus	400 000	2% vinyl acrylic 74% PVC 12% PES 12% cotton	X		X			
AquaClean	Altamura	80 000	81% polyester 12% macintosh 6% cotton 1% nylon	X				 	
AquaClean	Daytona	200 000	51% polyester 38% acrylic 11% polyamide	X	X			 	
Camira	X2	100 000	100% recycled polyester	X		X		  	
Camira	Main Line Flax	50 000	70% virgin wool 30% flax	X		X	On request		
Camira	Main Line Twist	50 000	75% virgin wool 30% flax	X		X			
Camira	Sumi	200 000	90% wool 10% polyamide	X		X	On request		
Gabriel	Step Melange	100 000	100% Trevira CS	X	X	X		 	
Kvadrat	Remix 3	100 000	90% new wool worsted 10% nylon		X	X			
Nevotex	Studio CS	70 000	100% Trevira CS	X		X			
Spradling	Silvertex	300 000	100% vinyl topcoat 100% polyester backing	X					

Recycled fabric   
 Easy-clean fabric   
 Faux leather   
 Acoustic fabric   
 10 YEAR 10 year guarantee  
 Water repellent   
 Easy-water cleaning

PRICE CATEGORY 4

Brand	Design	Martindale	Composition	Flammability standard				Sustainability	Other
				EN 1021 1 & 2	BS 5852		IMO		
					Part 1 0 & 1	Part 2 5 Crib			
Camira	Kyoto	200 000	90% wool 10% polyamide	X		X	On request		
Camira	Oceanic	100 000	100% post-consumer recycled polyester excl. 50% SEAQUAL® YARN	X		X		  	
Camira	Synergy	100 000	95% virgin wool 10% polyamide	X		X	On request		
Gabriel	Fame	200 000	95% New Zealand wool 5% polyamide	X		X		 	
Kvadrat	Re-wool 2	100 000	45% recycled wook 45% new wool 10% nylon	X	X	X		 	

PRICE CATEGORY 5

Brand	Design	Martindale	Composition	Flammability standard				Sustainability	Other
				EN 1021 1 & 2	BS 5852		IMO		
					Part 1 0 & 1	Part 2 5 Crib			
Camira	Blazer	45 000	100% virgin wool	X		X	On request		
Camira	Yoredale	50 000	95% wool 3% polyester 2% polyamide	X		X	On request		
Kvadrat	Canvas 2	100 000	90% new wool worsted 10% nylon	X	X	X			
Kvadrat	Steelcut Trio 3	100 000	90% new wool 10% nylon	X	X				

**intuit**  
BY SOFTREND

**Are You Intuit?**

 [intuitoroffice.com](https://intuitoroffice.com)

 [intuit\\_office](#)

 [Intuit by Softrend](#)

 [Intuit by Softrend](#)

Browse the Collection

