

Spot

Multifunctional seating furniture

Design: Pent Talvet, Iseasi

NEW



FIRE
RESISTANT
FABRICS



FIRE
RESISTANT
FOAM



CERTIFIED
WOOD
ONLY



5 YEAR
GUARANTEE

Just the place to be

Spot is a centre of attraction, one that dominates both the Welcome and Social zones. The four modules can be used to create varied solutions for one or more seated individuals. Whether Spot offers privacy to the person who is waiting or facilitates communication is purely a question of placement.

Always practical, Spot is a combination of an inviting seating area and a useful supporting surface. The shelves surrounding the seat form ideal supports on which to place a computer or simply to lean against. The shelves feature recessed sockets, enabling Spot to serve as a workspace, if desired. In addition to books and houseplants, the shelves confidently support various furnishing elements that enliven the office space. Spot also makes it easy to divide rooms into zones.

Attracts people
and things.



Welcome Zone



Social Zone

Suitable for the Welcome and Social zones because it:

- is a comfortable place to wait;
- can serve several functions;
- helps to create an inviting atmosphere.

Product information

Frame

Plywood

Upholstery

Seats and backrest have durable and fireproof HR foam and batting; seat cushions and backrest pillows are fixed

Standard Fabric Collection

Structured fabrics recommended

Shelving

Pine plywood with pine veneer back board, clear matte varnish; top board Forbo desktop linoleum Nero

Table

Forbo desktop linoleum Nero

Legs

Powder-coated metal, sand structure, matte black RAL 9005; anti-slip soles (optional)

Modularity

Modules can be connected together

Additional information

The cover fabric is not removable

Plug in options (optional)

Electric outlet: Powerdot Mini 50 1x type F-type socket; Powerdot Mini 52 2x USB-C; Powerdot Mini 51 2x USB-A



Dimensions

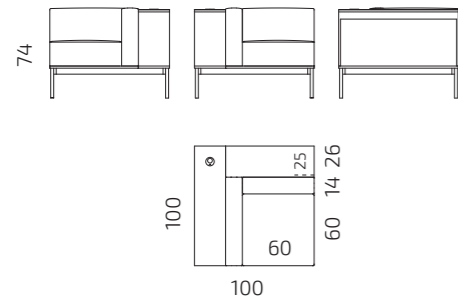

Module A left handed configuration
S126-1CLA

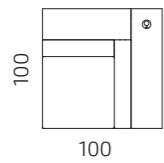

Module A right handed configuration
S126-1CRA

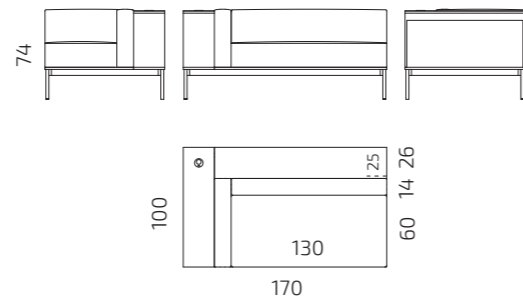

Module B left handed configuration
S126-2CLB

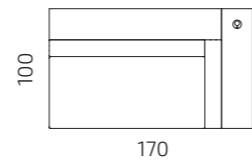

Module B right handed configuration
S126-2CRB

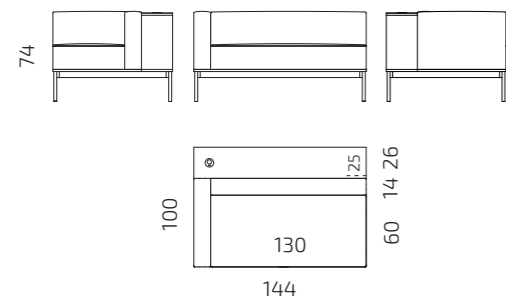

Module C left handed configuration
S126-2CLC

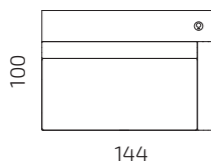

Module C right handed configuration
S126-2CRC

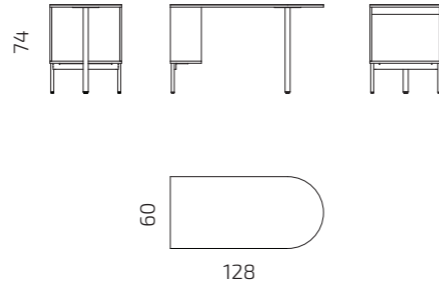

Module L - Table
S126-T1

All dimensions provided in centimetres.

Modules



Module A



Module B



Module C



Module L

Combinations

